



GigaBeam WiFiber G1.25

Gigabit Ethernet Millimeter Wave Radio

Installation & Operations Guide

Document #100254-001, Rev 01



GigaBeam WiFiber G1.25

**Gigabit Ethernet
Millimeter Wave Radio**

Installation & Operations Guide

Document #100254-001, Rev 01



Notice

This guide is provided for informational use only. Every effort was made to ensure accuracy of information in this guide at the time of printing. GigaBeam Corporation reserves the right to provide updates to content information not available at the time this guide was printed.

Copyright

2006 GigaBeam Corporation, All rights reserved. GigaBeam and its logo are trademarks of GigaBeam Corporation. All other trademarks and registered trademarks are the property of their respective owners. No part of this guide may be reproduced manually or electronically without written permission from GigaBeam Corporation.

Trademarks

Cisco is the registered trademark or registered trademark of Cisco Systems, Inc. in the United States and/or other countries.

GigaBeam and the WiFiber product name are trademarks or registered trademarks of GigaBeam Corporation in the United States and/or other countries.

Linux® is the registered trademark of Linus Torvalds in the United States and/or other countries.

SolarWinds, Inc. is the registered trademark of SolarWinds in the United States and/or other countries.

Specifications, terms, and conditions are subject to change without notice. All trademarks and registered trademarks are the property of their respective companies.

Ordering information

This guide is an information product of GigaBeam Corporation. The ordering number for this Guide is 100254-001, Rev 01, published February 2006. For an additional copy or the latest product information, please visit us at our web site, www.gigabeam.com

Federal Communications Commission (FCC) Notice

The GigaBeam Ethernet Millimeter Wave Radio product line was designed to provide Gigabit class data communications for “last mile” applications. The product line is designed to be compliant with FCC rules contained in 47 CFR Part 101.63 to Part 101.147 and CFR Part 15.

FCC Part 15.21

CAUTION:



Modifications or changes made to this radio not expressly approved by GigaBeam, (the party responsible for FCC Compliance) could void your authority to operate the radio. In other words, unauthorized modifications could void the operating license conditions that mandate the use of FCC certified equipment.



Safety instructions

Retain all safety information for future reference. The following table defines precautionary safety terms used within this guide. Failure to observe these precautions when installing, using, or servicing this product violates this products intended purpose and may result in personal injury or damage to equipment.

Safety Definitions

Term	Description
DANGER	Indicates an imminently hazardous situation which, if not avoided, will result in death or serious injury.
WARNING	Indicates a potentially hazardous situation which, if not avoided, could result in death or serious injury.
CAUTION	Indicates a potentially hazardous situation which, if not avoided, may result in minor or moderate injury. It may also be used to alert against unsafe practices.

Always follow basic safety precautions when installing, using, or servicing this product to reduce the risk of fire, shock, and injury to person or damage to equipment. The GigaBeam WiFiber G1.25 radio is designed to meet FCC emission standards. The RF output exceeds FCC regulations for continuous exposure to millimeter wave energy.

SAVE THESE INSTRUCTIONS

Symbols

Safety symbols shown on the WiFiber G1.25 radio must be observed when operating, servicing, or repairing the radio. Failure to comply with safety precautions shown on the radio or in this guide violates the intended use of this radio.

The following safety symbols appear on the radio and/or in this guide:



GENERAL HAZARD

This symbol represents a general warning or caution.



CAUTION: HIGH VOLTAGE

This symbol represents a caution, risk of electrical shock.

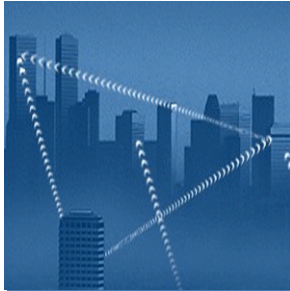

Contents

	About this guide	xv
	Purpose and scope	xv
	Audience	xv
	Related information	xv
	Link Management Center	xv
	Organization	xv
	Conventions	xvi
Chapter 1	WiFiber Radio Overview	1
	1.1 About the WiFiber G1.25 millimeter wave radio	2
	1.2 Applications	2
	1.3 Options	3
	1.4 Monitoring services	3
	1.5 Specifications	3
	1.5.1 General specifications	4
	1.5.2 Technical specifications	4
Chapter 2	Technical Description	5
	2.1 Radio description	6
	2.2 Millimeter wave subsystem	6
	2.2.1 Transceiver	7
	2.2.2 Modem	8
	2.2.3 Controller	8
	2.2.4 Power supply	8
	2.2.5 Antenna	8

Chapter 3	Installation and Setup	9
	3.1 Installation, setup, and commissioning	10
	3.2 Before you begin	10
	3.2.1 Site evaluation	10
	3.2.2 Inspection	10
	3.2.3 Inventory	10
	3.2.4 Required hardware, software and tools	11
	3.3 Physical description	12
	3.4 Transporting radio to site location	13
	3.5 Installing the radio mount	14
	3.6 Assembling and mounting the antenna	15
	3.7 Mounting radios	16
	3.8 Connecting cables to radio	18
	3.9 Commissioning radios	21
	3.9.1 About peaking	21
	3.9.2 Configuring radio for alignment via telnet/hyperterminal session	22
	3.9.3 Configuring radio for alignment via WiFiber Install application	24
	3.9.4 Validating radio configuration	28
	3.9.5 Setting radio date and time	29
	3.9.6 Testing radio installation	29
Chapter 4	Operations	31
	4.1 About the CLI	32
	4.2 Logging in	32
	4.2.1 About user privileges	32
	4.3 Navigating the CLI tree	32
	4.3.1 Setting integer, IP address, and string objects	34
	4.3.2 Setting enumerated integer objects (short-cut)	34
	4.4 Setting up	34
	4.4.1 Configuring the radio IP address	35
	4.4.2 Configuring the serial port	35
	4.5 Connecting to radios remotely	35
	4.5.1 Connecting via SSH	35
	4.5.2 Connecting via Telnet	36

	4.5.3 Using RADIUS To Authenticate logins	36
4.6	Common radio commands	37
	4.6.1 Saving configurations to flash	37
	4.6.2 Rebooting (soft)	37
	4.6.3 Configuring radio power	37
	4.6.4 Aligning radios using the RSSI graph	38
	4.6.5 Exiting the CLI	38
Chapter 5	Network Management	39
	5.1 About the SNMP	40
	5.2 Setting up SNMP communications	40
	5.3 Configuring community strings and access privileges	40
	5.4 Setting-up trap receivers	41
	5.5 Managing radios using a MIB browser	41
	5.5.1 Conducting a MIB walk-thru	41
Chapter 6	Advanced Operations	45
	6.1 Managing passwords	46
	6.1.1 Changing the admin password	46
	6.1.2 Changing the ruser password	46
	6.2 Managing in-band communications to radio (PPP access) ..	46
	6.3 Managing in-band communication link (DCC channel status)	48
	6.4 Viewing software & hardware revisions on radio	48
	6.5 Upgrading radio software	48
	6.6 Upgrading image remotely	50
Chapter 7	Maintenance & Troubleshooting	53
	7.1 Maintaining unit	54
	7.2 FAQs	54
	7.2.1 Unable to power radio	54
	7.2.2 Unable to communicate with radio	54
	7.2.3 Lost signal	55
	7.3 Diagnostics	55
	7.3.1 General diagnostics	55
	7.3.2 Obtaining an alarm status and alarm dump	56
	7.3.3 Setting traps	57

- 7.3.4 Enabling/disabling logs 58
- 7.3.5 Viewing logs 61
- 7.3.6 Obtaining radio error status 62
- 7.3.7 Verifying RSSI values 63
- 7.3.8 Checking Costas Lock to verify link communications . . . 65
- 7.3.9 Verifying optical link 66
- 7.4 Troubleshooting 67
 - 7.4.1 General troubleshooting 68
 - 7.4.2 Configuring loopbacks 68
 - 7.4.2.1 Activating/deactivating loopback mode 68
 - 7.4.2.2 Radio external loopback configuration 69
 - 7.4.2.3 SFP (customer) external loopback configuration 69
 - 7.4.2.4 Radio local loopback configuration 70
 - 7.4.2.5 Debugging loopback configurations 71
 - 7.4.2.6 Radio to SFP local loopback configuration . . . 72

- Appendix A Specifications 73**
 - A.1 Mount specifications 74
 - A.2 Raiser cabling specifications 74
 - A.3 Example transmitter power specifications 75

- Appendix B CLI Quick Reference 77**
 - B.1 CLI command tree table conventions 78
 - B.2 CLI command tree 78

- Appendix C Mechanical Drawings and Pinouts 97**
 - C.1 Radio Assembly Description (rear view) 98
 - C.2 Radio Assembly Description (rear view 2) 99
 - C.3 Radio Assembly Description (rear view 3) 100
 - C.4 LC/SC 9/125 SM Fiber Cable Assembly 101
 - C.5 LC/SC 62.5/125 MM Fiber Cable Assembly 102
 - C.6 LC/SC 50/125 MM Fiber Cable Assembly 103
 - C.7 10BaseT, CAT5 Cable Assembly 104
 - C.8 External Power CPC to 1/4" Ring Lug 105
 - C.9 Power Cable Pinouts 106

Appendix D	MIB Tree and Alarm Structures	107
	D.1 About the MIB tree structure	108
	D.2 About RCM alarm structures	110
	D.2.1 SummaryAlarm object	111
	D.2.2 GroupAlarmSfp1 object	112
	D.2.3 GroupAlarmMisc object	115
	D.2.4 GroupAlarmRad1 object	117
	D.2.5 GroupAlarmRad3 object	117
Appendix E	WiFiber Installer Console	119
	E.1 About the WiFiber Installer Console	120
	E.2 Installing the WiFiber Installer Console application	120
	E.3 Configuring console for radio	120
	E.4 WiFiber Installer overview	121
	E.4.1 Main tab	122
	E.4.2 IP Settings tab	124
	E.4.3 Alarm Settings tab	125
	E.4.4 TxPower Calculation tab	126
	E.4.5 WiFiber RSSI Alignment tab	128
	Glossary	131
	Index	135



Figures

Figure 1-1	WiFiber G1.25 millimeter wave radio.	2
Figure 2-2	Radio block diagram.	6
Figure 2-3	Radio links transmitting at 71-76 and 81-86 GHz.	6
Figure 2-4	Graph showing 71-76 and 81-86 GHz Tx Power levels.	7
Figure 2-5	Link distances with weather availability of 99.99 percent.	7
Figure 3-6	Antenna description.	12
Figure 3-7	Radio description.	12
Figure 3-8	U-Clamp and Mounting Assemblies.	13
Figure 3-9	Radio connectors.	18
Figure 7-10	Example of a MIB walk-thru of RSSI readings showing LVAI, LVAQ and verifies Costas Lock.	65
Figure 7-11	Radio External Loopback / Customer Local Loopback Configuration.	69
Figure 7-12	SFP (Customer) External Loopback path.	69
Figure 7-13	Radio Local Loopback configuration.	70
Figure 7-14	Radio to SFP Local Loopback path.	72
Figure D-1	The RCM SummaryAlarm Bitmap.	111
Figure D-2	The RCM GroupAlarmSfp1 bitmap.	113
Figure D-3	RCM GroupAlarmMisc Bitmap.	116
Figure D-4	The RCM GroupAlarmRad1 bitmap.	117
Figure D-5	The RCM GroupAlarmRad3 bitmap.	118
Figure E-6	WiFiber Installer Console - Main screen.	122
Figure E-7	WiFiber Installer Console - IP Settings screen.	124
Figure E-8	WiFiber Installer Console - Alarm Status screen.	125
Figure E-9	WiFiber Installer Console - TxPower Calculator screen.	126

Figure E-10 WiFiber Installer Console - Tx Power Calculator parameters. . . 127
Figure E-11 WiFiber Installer Console - RSSI Alignment screen. 128



Tables

Table 3-1. Connectors and LED Description	19
Table 4-2. CLI Common Navigation Commands	33
Table 5-3. MIB Access Privileges	40
Table 5-4. Trap Receivers	41
Table 7-5. Debugging Loopback Object Bitmap Description	71
Table A-1. Transmitter Power Example	75
Table A-2. RSSI Example	76
Table B-3. CONFIG Commands	78
Table B-4. CONFIG / SFP / SFP1 Commands	78
Table B-5. CONFIG / SFP / SFP1/ BASE Commands	79
Table B-6. CONFIG / SFP / SFP1 / EXT Commands	79
Table B-7. CONFIG / SFP / SFP1 / THRES Commands	80
Table B-8. CONFIG / SFP / SFP1 / CALIB Commands	81
Table B-9. CONFIG / SFP / SFP1 / AD Commands	81
Table B-10. CONFIG / SFP / SFP1 / STATUS Commands	82
Table B-11. CONFIG / SFP / SFP1 / FLAG Commands	82
Table B-12. CONFIG / SFP / SFP1 / VENDMEM Commands	83
Table B-13. CONFIG / SFP / SFP1 / GBEAM Commands	83
Table B-14. CONFIG/ SFP / SFP1 / TRAP Commands	83
Table B-15. CONFIG / RAD Commands	84
Table B-16. CONFIG / RAD/ BASE Commands	85
Table B-17. CONFIG/ RAD / EXT Commands	85
Table B-18. CONFIG / RAD / THRES Commands	86

Table B-19. CONFIG / RAD / DIAG Commands	86
Table B-20. CONFIG / RAD / STATUS Commands	86
Table B-21. CONFIG / RAD / CONTROL Commands	87
Table B-22. CONFIG / RAD / FLAG Commands	89
Table B-23. CONFIG / RAD / AD Commands	89
Table B-24. CONFIG / RAD / DS Commands	90
Table B-25. CONFIG / RAD / TRAP Commands	90
Table B-26. CONFIG / STAT Commands	91
Table B-27. CONFIG / STAT / REV Commands	91
Table B-28. CONFIG / STAT / PSM Commands	91
Table B-29. CONFIG / STAT / ALARM Commands	92
Table B-30. CONFIG / STAT / SFP Commands	92
Table B-31. CONFIG / CONF Commands	92
Table B-32. CONFIG / CONF / CONTROL Commands	93
Table B-33. CONFIG / CONF / ASYNC Commands	93
Table B-34. CONFIG / CONF / TFTP Commands	94
Table B-35. CONFIG / CONF / SNMP	94
Table B-36. CONFIG / CONF / ETHERNET Commands	95
Table B-37. CONFIG / CONF / MISC Commands	95
Table B-38. CONFIG / DIAG Commands	95
Table C-39. Mini CPC Power Cable Connector Pinouts	106
Table D-40. MIB Tree Structure Objects and Description	108
Table D-41. Varbinds of the Enterprise Specific Traps	110
Table D-42. Summary Alarm and Group Alarm Traps	112
Table D-43. GroupAlarmSfp1 Object Traps	114
Table D-44. GroupAlarmMisc Traps	116
Table D-45. GroupAlarmRad1 Traps	117
Table D-46. GroupAlarmRad3 Traps	118

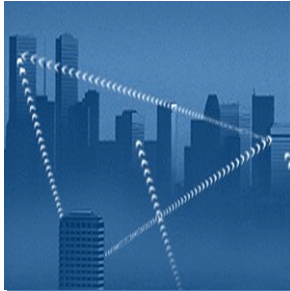

Preface

About this guide

Purpose and scope

The purpose of this guide is to introduce you to the WiFiber G1.25 radio and to help you successfully install and use this product. The scope of this guide describes the product features, capabilities, and applications, and provides task-based instructions for installing, commissioning, and performing basic network monitoring using the WiFiber G1.25 radio.

Audience

This guide is intended for the first time or occasional installer of the WiFiber G1.25 radio who have experience in telephony and microwave communications. This guide is also intended for system integrators who are setting up monitoring or integrating the radio system into their network environment and who have experience in network management. More experienced users may find sections useful for reference purposes and troubleshooting.

Related information

Use this guide with the following documents:

- GigaBeam Site Survey
- GigaBeam WiFiber G1.25 Network Operations Guide

Link Management Center

For technical support, call the Link Management Center (LMC) at GigaBeam, 1-800-943-4442 or e-mail support@gigabeam.com. Our website at www.gigabeam.com also provides helpful information.

Organization

This guide is organized into task-based instructions to help you quickly install, setup, and use the WiFiber G1.25 radio. If you are a first time user doing an installation, first read the Overview, Technical Description, and Installation chapters, if you are performing system monitoring or integrating the radio into your network environment, continue

reading the chapters on Operations, Network Management, and Advanced Operations. Use the remainder of this guide as a reference when needed. If you are an experienced user, use this guide as a reference to review procedures or for particular tasks and to solve problems.

Conventions

The following table describes typographical and icon conventions used throughout this guide.

Conventions

Description	Example
Text that displays on the screen appears in this <code>typeface</code> .	The prompt displays: <code>#GVFR(config)#</code>
Text you must enter exactly as shown appears in this typeface .	Type conf <code>GVFR(config)#conf</code>
A greater than symbol (>) indicates choosing a submenu from a menu.	Click File > Open .
An arrow represents a tip or note and conveys related information.	

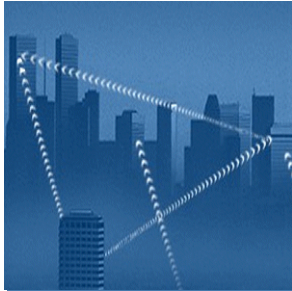

Chapter 1

WiFiber Radio Overview

This chapter provides a general description of the WiFiber G1.25 radio. Topics discussed are as follows:

- “About the WiFiber G1.25 millimeter wave radio” on page 2
- “Applications” on page 2
- “Options” on page 3
- “Monitoring services” on page 3
- “Specifications” on page 3

1.1 About the WiFiber G1.25 millimeter wave radio

The GigaBeam Millimeter Wave Radio product line is a wireless communications solution designed to provide Gigabit class data communications for “last mile” (last kilometer) applications, [Figure 1-1](#).



Figure 1-1 WiFiber G1.25 millimeter wave radio.

The WiFiber G1.25 includes the following features and capabilities:

- The WiFiber G1.25 is designed to be compliant with FCC rules contained in 47 CFR Part 101.63 to Part 101.147.
- The radios operate in the 71-76 and 81-86 GHz radio spectrum bands using a dual band Frequency Division Duplexing (FDD) architecture. The radio modulation format is BiPhase Shift Key (BPSK), differentially encoded, resulting in a two level BPSK operating at 1 bit per hertz spectral efficiency.
- The radios use standard optical interfaces for Ethernet Gig E data terminals.

1.2 Applications

The WiFiber G1.25 can provide a variety of last mile (last kilometer) applications:

- Fiber (backbone) POP access
- Redundant Access – Network Diversity
- Enterprise Campus Connectivity
- Local Area Network (LAN) Extension
- Local Loop
- Metropolitan Area Network (MAN)

- Wide Area Network (WAN) Access
- Central Office Bypass
- Storage Access (Storage Area Networks (SAN) and Network Attached Storage (NAS))
- Wireless Backhaul (3G and 4G)
- High Definition Video

1.3 Options

GigaBeam provides several options of the WiFiber G1.25 radio systems to meet your wireless communication needs:

- Standard: 62.5 micron single-mode
- Options (special order):
 - 50 Micron single mode
 - 50 Micron multi-mode

1.4 Monitoring services

The Link Operations Service offering from GigaBeam provides a comprehensive program of network operations, implementation support, and professional services of network engineering, link design, and integration support.

GigaBeam's Link Operations Service is delivered through the combined capabilities of three distinct components:

- **Link Management Center (LMC):** A dedicated, carrier-class facility staffed by experienced engineers that provide 24x7x365 support and monitoring operations.
- **Implementation & Installations Services:** A dedicated team of qualified project management and installation engineers to support any Inside Wiring, facilities and building maintenance solutions.
- **Link Operations Professional Services:** A dedicated team of highly qualified Network Engineers available to support the customer on all Link integration configurations.

GigaBeam markets the LMC directly to customers as part of a tiered maintenance program or through our Managed Services offerings of Network Services. A typical Link installation will consist of a standard tiered service offerings based on customer need or requirements.

1.5 Specifications

This section describes both WiFiber G1.25 general and technical specifications.

1.5.1 General specifications

- **Weather availability:** 99.999% at ~1mile (~1.6 km) - approximately 80% of the United States. In parts of the U.S. subject to more tropical down pours—like Miami—radios transmit range for 99.999% availability is ~0.7 miles (one km).
- **Native network compatibility:** GigE
- **Switched network compatibility:** 100Mb, DS-3, OC-3, and OC-12
- **OSI layer:** Physical Layer 1
- **Commercial applications:** FCC Part 101 license
- **Federal applications:** NTIA Frequency Assignment
- **Beam width:** <1° (Antenna size dependent)
- **Monitoring:** SNMP via Ethernet 10/100 Interface
- **Signal interface:** LC Single or Multi-mode Optical Connector (Installation dependent)
- **Power input:** (40-100 Watts), -48 VDC
- **Antenna size:** Varies by installation, nominal 2 feet (60 cm)
- **Weight:** Antenna, 37lbs (16.78 kg) and Radio, 11 lbs (5.0 kg)
- **Temperature range:** - 33° to + 55° C

1.5.2 Technical specifications

- **Frequency:** 71-76 GHz and 81-86 GHz
- **Transmit power:** +20 dBm (100 mW) for 71-76 GHz and 81-86 GHz
- **Noise Figure:** 10 dB (system level)
- **Transmit power control range:** ~20 dB
- **System Gain - above threshold:** 177 dB
- **Threshold (at 1.25 Gigabits):** -50 dBm
- **Spectral Efficiency:** 1 bit per hertz (Nyquist - calculated)
- **Antenna Gain:** 50 dB @ 71 GHz and 52.5 dB @ 86 GHz
- **Data Rate:** 1 Gigabit
- **Signaling Rate:** 1.25 Gigabits
- **Data Format:** 802.3z Gigabit Ethernet
- **Center Frequency:** 73.5 GHz and 83.5 GHz



Chapter 2

Technical Description

This chapter provides a technical description of the WiFiber G1.25 radio. Topics discussed in this chapter are as follows:

- “Radio description” on page 6
- “Millimeter wave subsystem” on page 6
 - “Transceiver” on page 7
 - “Modem” on page 8
 - “Controller” on page 8
 - “Power supply” on page 8
 - “Antenna” on page 8

2.1 Radio description

The WiFiber G1.25 radio is a high data rate point-to-point communications device optimized for 1 Gigabit of Ethernet traffic. The radio operates in a dual band FDD format meeting the technical standards of FCC regulations contained in 47 CFR Part 101.63 - Part 101.147. The radio bands used are 71-76 GHz and 81-86 GHz.

The following block diagram illustrates the WiFiber G1.25 radio operation.

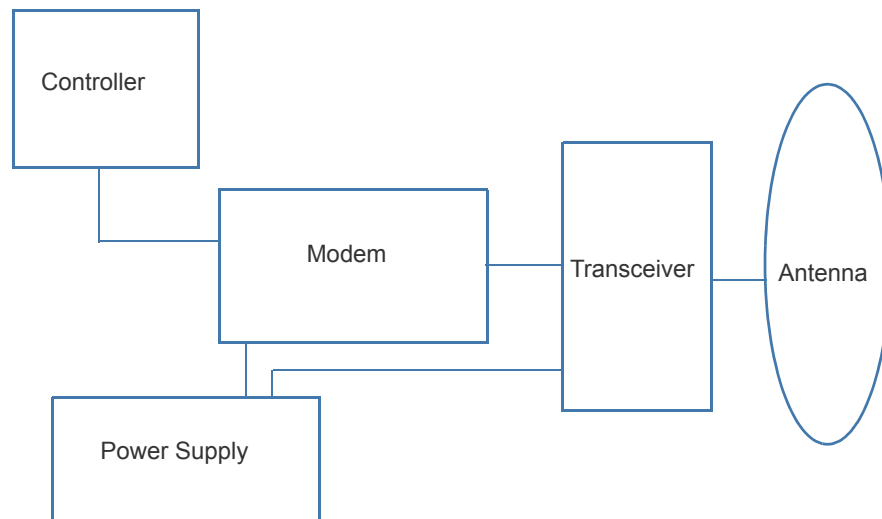

Figure 2-2 Radio block diagram.

2.2 Millimeter wave subsystem

- The system operates Dual Band FDD: one end of the link transmits within the 71 GHz band and receives within the 81 GHz band. The other end of the link does the inverse: transmits within the 81 GHz band and receives within the 71 GHz band, Figure 2-3.

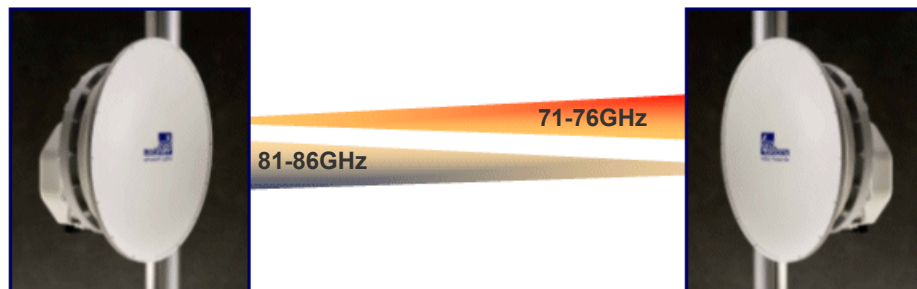

Figure 2-3 Radio links transmitting at 71-76 and 81-86 GHz.

Figure 2-4 illustrates how GigaBeam technology maximizes the potential of the FCC authorized optimum frequency bands that enable multi-gigabit-per-second communications. The graph indicates, the 60GHz frequency band is impeded by high oxygen absorption and FSO (light wave) frequencies are severely

affected by fog.

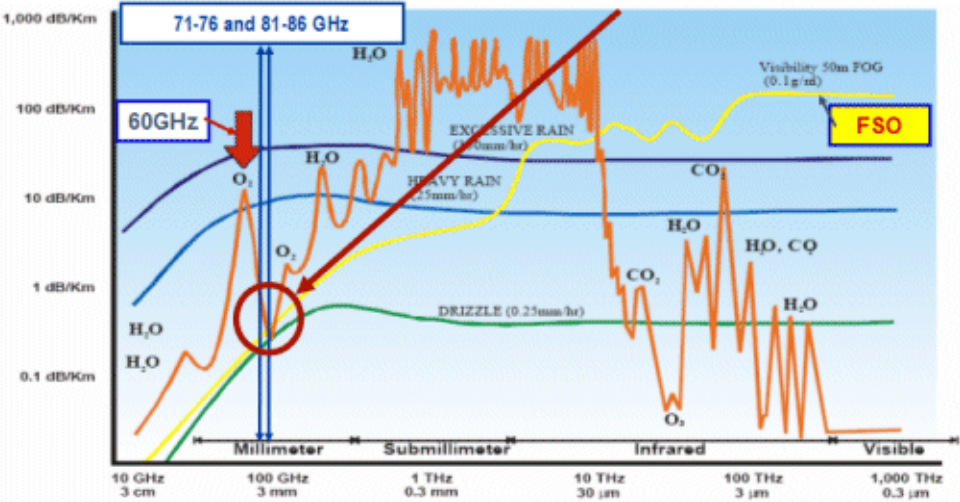

Figure 2-4 Graph showing 71-76 and 81-86 GHz Tx Power levels.

Using the 71-76 GHz and 81-86 GHz frequency bands, Figure 2-5 shows GigaBeam communications link lengths by U.S. regions at 99.9% and 99.999% weather availability.

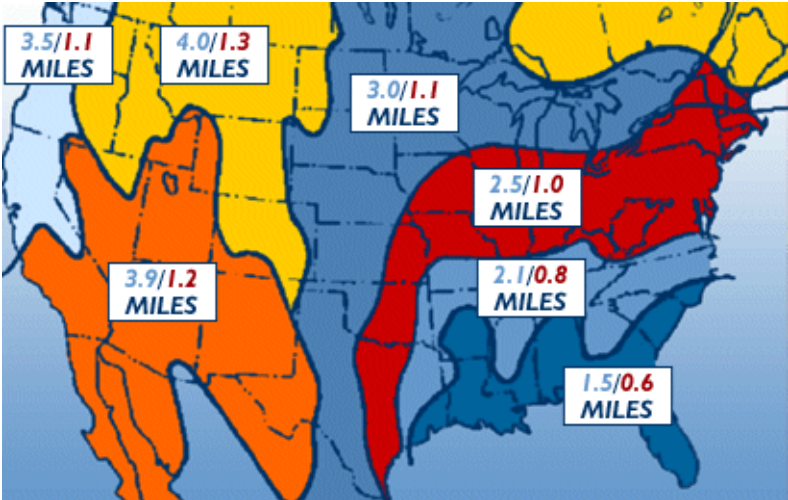

Figure 2-5 Link distances with weather availability of 99.99 percent.

2.2.1 Transceiver

The transceiver is a multi-functional device that sends and receives data and includes a receiver, transmitter, and synthesizer. This is a GigaBeam custom design.

Receiver. The receiver is a single conversion unit.

Transmitter. The transmitter output results from digital modulation driven into a modulating mixer just prior to the power amplifier.

Synthesizer. The Local Oscillator signal is created in a low-noise, high-stability, phase-locked source and is multiplied to appropriate frequencies.

2.2.2 Modem

The modem is a data interface system that performs two functions: data generation and data recovery. The system operates with industry standard Ethernet at 1.25 Gigabits per second. Forward Error Correction (FEC) is enabled by default and is always active. This is a GigaBeam custom design.

2.2.3 Controller

The controller is a subsystem powered by a microprocessor. The operating system provides powerful software capabilities such as the CLI and the SNMP, which commands the radio to transmit upon receipt of a valid network management input. The subsystem also monitors vital signals from the radio system and reports status to the network management system. This is a GigaBeam custom design.

2.2.4 Power supply

A power supply converts 48 Volts DC (VDC) to required voltages needed within the radio. An external 120 Volts AC (VAC) rectifier will provide the 48 VDC source.

2.2.5 Antenna

The 2' (60 cm) antenna is a GigaBeam custom design.

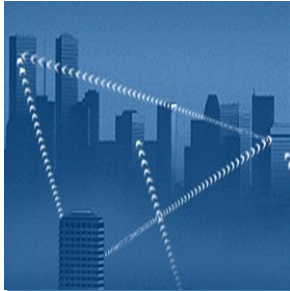

Chapter 3

Installation and Setup

This chapter describes how to install, setup, and commission the WiFiber G1.25 communication radios. Topics discussed in this chapter are as follows:

- “Installation, setup, and commissioning” on page 10
- “Before you begin” on page 10
- “Physical description” on page 12
- “Transporting radio to site location” on page 13
- “Installing the radio mount” on page 14
- “Assembling and mounting the antenna” on page 15
- “Mounting radios” on page 16
- “Connecting cables to radio” on page 18
- “Commissioning radios” on page 21

3.1 Installation, setup, and commissioning

The WiFiber G1.25 radio channel frequencies are factory set when delivered. This being the case, the radios are fully commissioned after completing the following tasks:

- Preparing the site per the site survey
- Mounting the antenna and radio
- Connecting cables
- Configuring and peaking radios

3.2 Before you begin

Prior to the installation process, verify and validate that the site is prepped with the proper cabling; that you have the prerequisite tools required for the installation; and that the parts supplied are included and not damaged.

3.2.1 Site evaluation

Verify installation of demarcation point or Minimum Point of Entry (MPOE):

- Cables terminate in a NEMA-3R or greater PVC/Metal box.
- PVC/Metal box contains patch blocks for the optical, data, and power cabling to interconnect the raiser cables to the radio feed cables.
- All cables must run through a properly secured and shielded PVC or EMT conduit to the buildings entry point. In most cases, this will be flexible 1" (2.5cm) liquid-tight conduit (containing cabling and associated fittings) to metal box, point of demarcation.

3.2.2 Inspection

When you receive the WiFiber G1.25 radio, inventory and inspect all components. If you observe damage or missing items, contact Link Management Center.

3.2.3 Inventory

The WiFiber G1.25 radio provides multiple options, verify box labels and radio labels to ensure you have received the desired WiFiber G1.25 radio system (refer to Site Survey for guidance if needed).

The WiFiber G1.25 radio system includes the following components:

- 2 Radios: (1) 73.5 GHz radio and (1) 83.5 GHz radio
- 2 Transmission Power Specification Charts (1 for each radio)
- 2 Antennas (1 for each radio)
- 2 Hardware Kits (1 for each radio) containing

- Assembly Mount
- U-clamp
- Bolts
- Washers
- Site specific components
 - Site survey
 - Electronic files include WiFiber Installer application with friendly user-interface, MIB file, and Power Calculator Utility Tool
 - Cables (from demarcation point to radios, the cable length will vary for each site)
 - Fiber Optic cable
 - Ethernet Data cable
 - Power cable with pigtails
 - Pole Mount assemblies including protective rubber composite protective pad, options are as follows:
 - Pole mount
 - Tripod mount
 - Wall mount

3.2.4 Required hardware, software and tools

Installation of each WiFiber G1.25 radio requires the following tools:

- Volt meter
- (2) 48 VDC Power supplies (1 for each radio) and 6' (2 m) power cord
- PC
 - RS232 Serial port (if using hyperterminal), female-to-female, DB9 serial cable
 - Ethernet card with cross-over cables, male-to-male (if telneting)
 - Hyperterminal or equivalent software
 - MIB browser software (optional)
- Hands-free communication device (radio or cell phone)
- Miscellaneous hand tools:
 - Screw driver
 - 1/2" (13 mm) Wrench (additional wrenches of assorted sizes)
 - Socket set
 - Magnetic level
 - Flashlight
 - 5/16" (8 mm) 18 TPI (threads per inch) eye bolt
 - Temporary mount (required to support azimuth alignment)

- Safety equipment appropriate for mounting environment
- Other tools may be required depending on the site environment

3.3 Physical description

The following figures illustrate WiFiber G1.25 radio components.

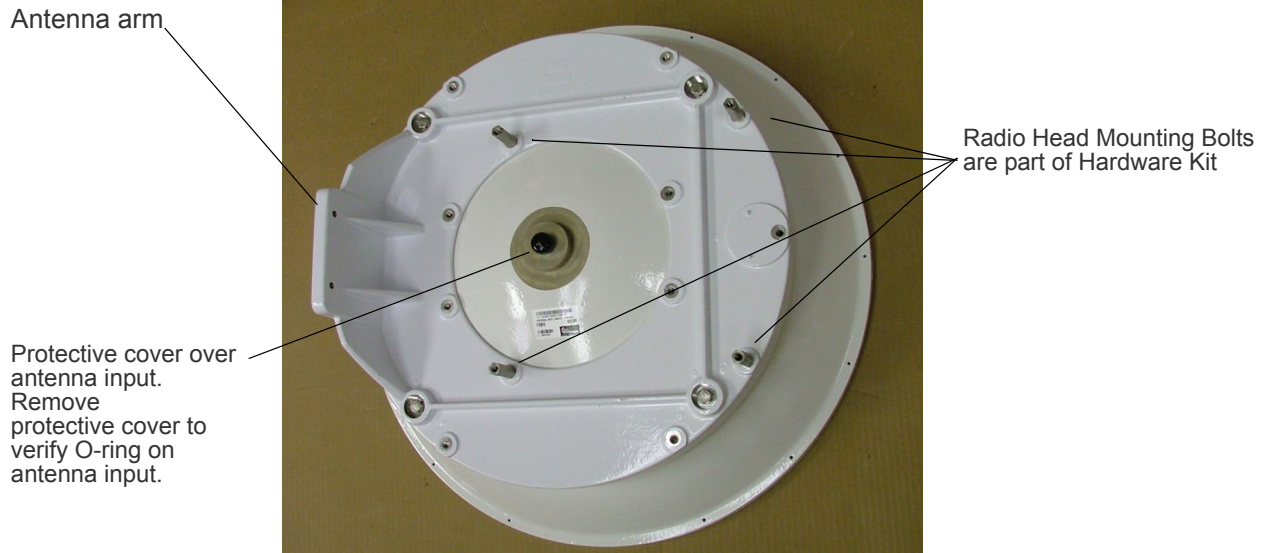
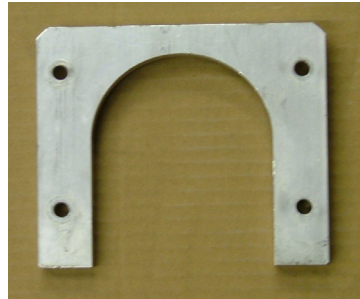

Figure 3-6 Antenna description.



Figure 3-7 Radio description.



U-clamp attaches to antenna for mounting

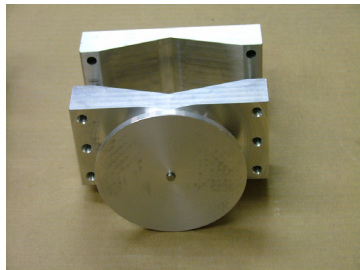

Mounting Assembly

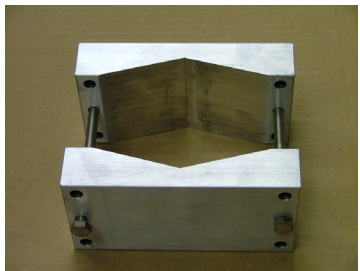

Temporary Mounting Assembly
 (part of Technicians tool set)

Figure 3-8 U-Clamp and Mounting Assemblies.

The following cables are needed to install the radio system. Cables are specified in the site survey as lengths are specific to each site. For technical cable descriptions, see [Appendix C “Mechanical Drawings and Pinouts”](#) on page 97.

- Fiber Optic Cable with LC or SC connector
- Ethernet Cable with RJ45 connector
- Power cables with pigtails

3.4 Transporting radio to site location

Often the radio must be taken to the top of a building, which requires carrying the radio system up flights of stairs and ladders. The radio and components are designed to easily fit into a backpack.

To hoist antenna up a ladder or pole

- 1 Insert eye bolt into arm of antenna.
- 2 Tie a rope through the eye bolt.

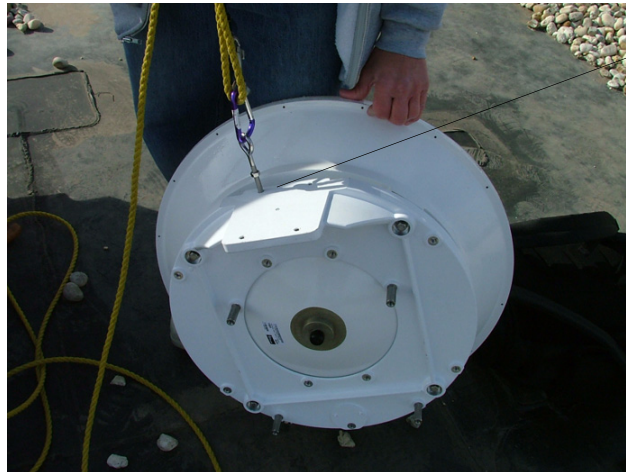

Eye bolt in antenna arm

- 3 Carefully raise antenna.

3.5 Installing the radio mount

The radio mount must be attached to a solid surface with structural integrity. This will help secure the radio and its alignment in adverse conditions such as heavy storms.

- 1 Clean the mounting surface of any debris. If it is a rooftop, clear away any stones or pebbles.
- 2 Place a protective mat on surface if needed.
- 3 Construct radio mount per site survey recommendations, see also “[Mount specifications](#)” on page 74).
 - The radio is designed to mount on a 3” (8 cm) or 4” (10 cm) pole.
 - The pole must be installed and secured prior to mounting the radio.
- 4 Attach Temporary Mounting Assembly to the pole. This assembly supports the radio and antenna during installation and peaking.
- 5 Attach Mounting Assembly plumb to surface above the Temporary Mounting Assembly on the pole. The Mounting Assembly is adjustable for a 3” (8 cm) or 4” (10 cm) pole. The bolts on the Mounting Assembly allow it to adjust to the pole diameter and should be 1” (3 cm) larger than the pole diameter. For example, a 3” (8 cm) pole requires 4” (10 cm) bolts and a 4” (10 cm) pole requires 5” (12 cm) bolts for the Mounting Assembly. The bolts on the Mounting Assembly adjust the radio horizontally during the peaking process.

NOTE:

▶ Do not over-tighten bolts. Tighten bolts enough to secure the radio, while allowing the ability to adjust the radio horizontally while peaking.

3.6 Assembling and mounting the antenna

To assemble and mount the antenna

- 1 Attach the U-clamp to the antenna arm using the captive screws. The nipple on the Mounting Assembly fits into the hole on the antenna arm.

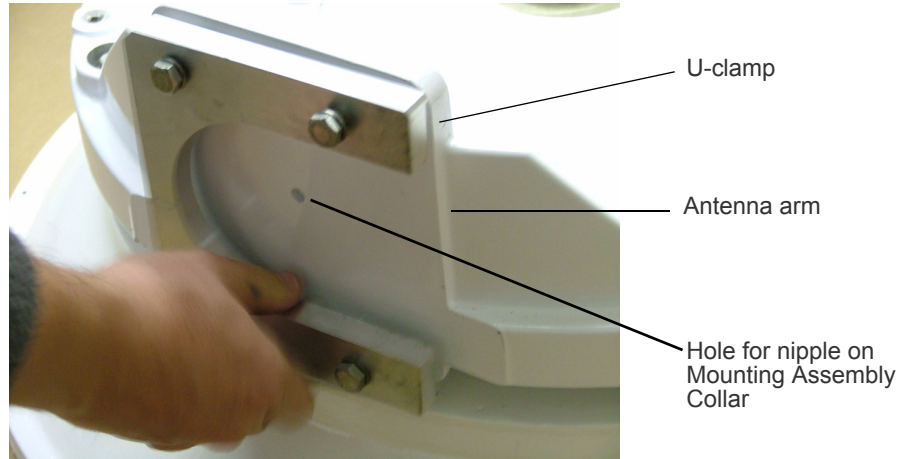

- 2 Remove protective cover over antenna input and verify the O-ring around the antenna input is in place.
- 3 Insert 4 (four) Radio Head Mounting bolts for the desired radio polarization: vertical or horizontal. Refer to [Appendix C “Mechanical Drawings and Pinouts” on page 97](#) for positioning Radio Head Mounting Bolts for vertical or horizontal polarization. When considering antenna position, verify that the position will allow moisture to properly drain through weep hole, see [“Radio Assembly Description \(rear view\)” on page 98](#). The illustration below illustrates positioning of Radio Head Mounting Bolts for vertical and horizontal polarization.

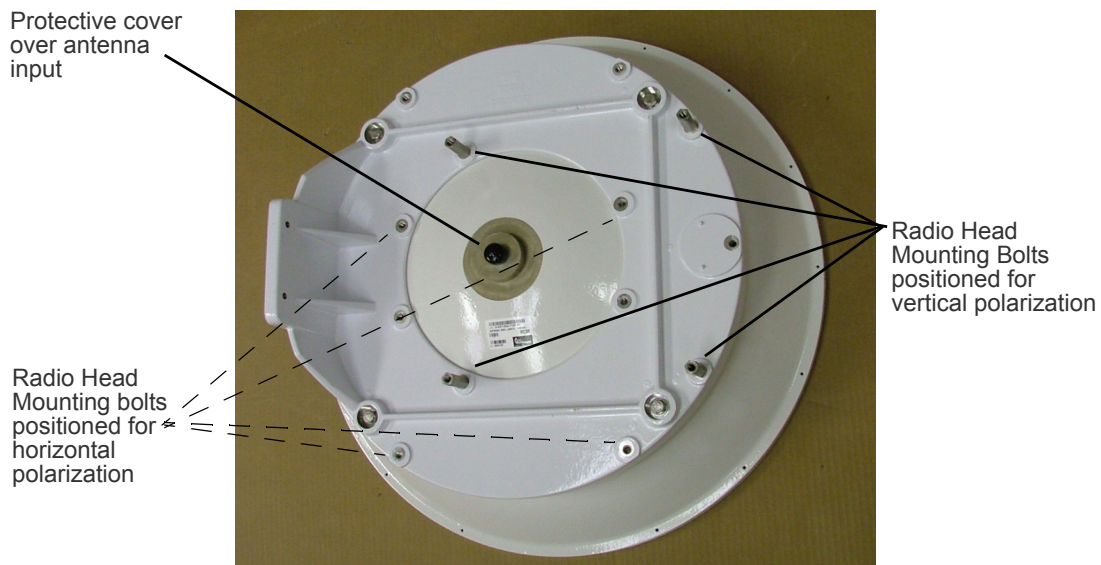

- 4 Mount antenna on pole.
 - a Slide U-clamp on assembled antenna over the Mounting Assembly Collar on pole and tighten bolts to secure radio.

The nipple on flat circle of Mounting Assembly Collar fits into the hole on the antenna arm.

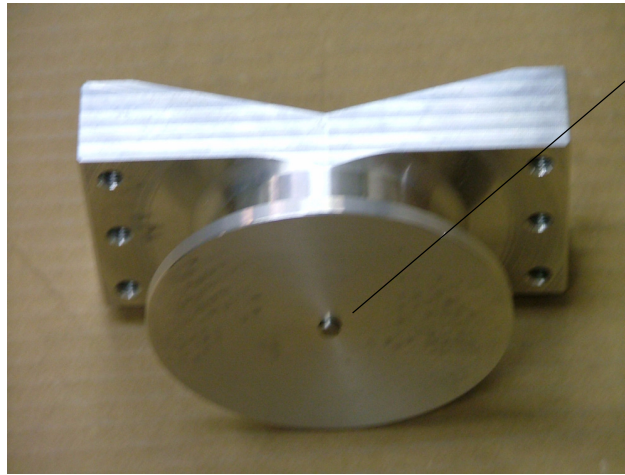

Nipple fits into antenna arm

- b** Tighten bolts on the U-clamp. Tightening bolts secures the antenna and supports the vertical radio alignment during the peaking process.



4 Bolts on Mounting Assembly Collar (2 on each side) support vertical peaking process.

U-clamp over Mounting Assembly Collar

NOTE:



Do not over-tighten bolts. Tighten bolts enough to secure the radio, while allowing the ability to adjust the radio vertically during the peaking process. Use a lubricant, such as WD40, or similar, as needed.

3.7 Mounting radios

- 1** If mounting on a tower or pole, attach a safety line to radio and secure it to protect the radio from being dropped.

Warning: Equipment damage



Attach a safety harness to radio to protect it from being dropped on a hard surface. Dropping the radio on a hard surface may damage radio.

- 2 Mount radio to rear of antenna.
 - a Mount radio to antenna so that connectors are easily accessible and not blocked or difficult to reach.
 - b Place radio over O-ring on antenna input. It should fit tightly over antenna to ensure proper sealing and protection from elements.

Fits tightly over
O-ring on
antenna input

Hooks on four corners
to twist over Radio
Head Mounting Bolts
on antenna.

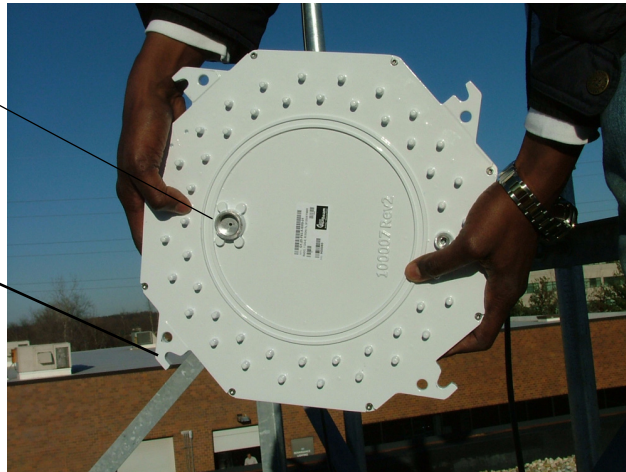

- c Twist radio so that the radio hooks latch over the Radio Head Mounting Bolts on antenna.



- d Tighten all four (4) Radio Head Mounting Bolts to secure radio to antenna. Begin tightening bolts in opposite corners of radio to best secure radio.



Tightening Radio Head
Mounting Bolts

3.8 Connecting cables to radio

After mounting radios on mounting assembly, you are ready to connect cables to the radio. Connectors and LED are all positioned at the rear of the radio.

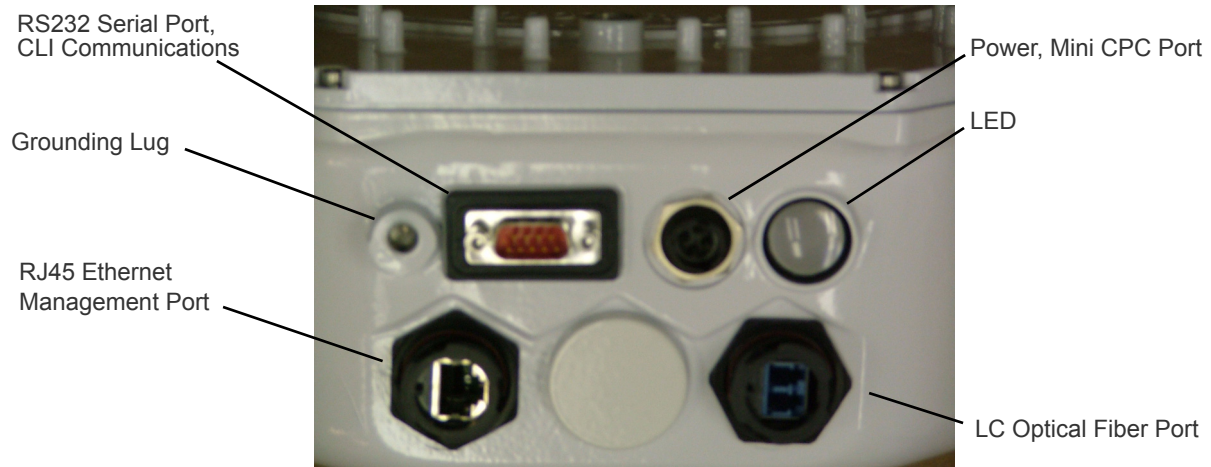

Figure 3-9 Radio connectors.

Table 3-1 Connectors and LED Description

Connector	Description
Serial Port	RS232 serial port for CLI communications. Upon unpacking of radio, the serial port includes weather, protective cover.
Power	Mini CPC Port for powering radio.
LED	<ul style="list-style-type: none"> - Green illumination. Indicates non-alarm condition. - Amber illumination. Indicates system power up. - Red illumination. Indicates alarm condition.
Ethernet Port	RJ45 Ethernet port provides Management capability.
Optical Fiber Port	LC fiber port.

Note:



LED illumination will vary based on power feed to radio. If only one power source is in use, the LED will illuminate red after ~1 minute of warm-up to indicate the radio system is fully powered. If two feeds are in use to power radio (standard configuration), the LED will illuminate green after ~1 minute warm-up to indicate radio system is fully powered, unless there is an error indicating an alarm condition (red LED).

- 1 Before connecting cables to the radio, aim radio antenna away from other link to avoid possibly damaging the radio receiver with high power levels.

WARNING: Equipment Damage



Aim radios away from opposite link before applying power to the radio. High power levels in radios in close proximity to one another (~1/4 mile) will damage the radio receivers.

- 2 Connect Ethernet Data cable (RJ45 connector) for remote management of the radio to Ethernet port on radio.
- 3 Connect -48VDC power cable with pigtails (takes up to 12 gauge wire) to the radio.
- 4 All cables should be grounded and shielded when connecting to the radio. Ground the entire mast and any surge protection device to building steel using the most direct run to the ground point. Ground wire must be 10 gauge, green

jacketed wire. (Use industry standard shielding and grounding practices for all rooftop installations.)



Attach ground cable to threaded screw hole on radio

- 5 Connect Ethernet and Optical Fiber cables to Distribution box (point of demarcation).

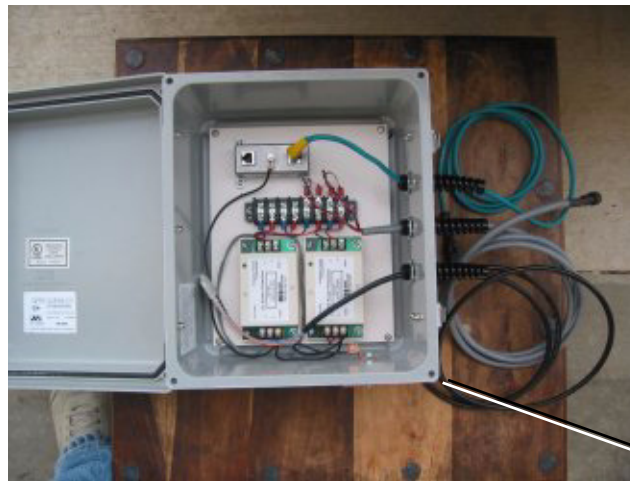

Distribution box (point of demarcation)

- 6 If an external power supply was purchased to install with radio, connect Power cables to external power supply.

Warning: Electric shock



Ensure 110 VAC cable is not plugged into wall outlet to avoid shock and possible equipment damage.

The following describes a typical example of a local power supply installation. If the power supply is remotely located, for example in the Switch room the preferred location, provide wire of suitable gauge for that distance (see [Appendix A "Specifications" on page 73](#)). In some cases, the cable run may need to be Plenum jacketed cable to adhere to building codes, see Site Survey.

- a Connect 110 VAC cable to external power supply.
 - Green connector to ground (\perp) on power supply.
 - White connector to neutral (N) on power supply.

- Black to live (L) on power supply.
- b Connect Power Cable to power supply.
 - Attach both black pigtail connectors to the +V on the power supply.
 - Attach both red pigtail connectors to the –V on the power supply. The following shows a typical example of connectors on a power supply.



- c Connect 3-prong 110 VAC plug to wall outlet.
The LED indicator on the radio will illuminate amber for a second and then go off. After ~1 minute the LED will illuminate red indicating the radio system is fully powered.
- 7 Secure power supply in an environmentally protected location/box per Site Survey guidance.

This completes the radio system installation, now you are ready to commission the radio for operation.

3.9 Commissioning radios

After connecting cables to the radio, you are ready to commission the radios. Commissioning of radios is the process of configuring the radio for alignment and then *peaking* the receive signal at each end of the link. For fine gain antenna pointing, carefully scan the antennas, one at a time, in a raster fashion to cover azimuth and elevation. This scanning method, or *peaking* procedure, will ensure that you locate the antenna maximum.

3.9.1 About peaking

Peaking refers to aligning the finite radio beams at the maximized receive power level. Because radios are installed at a distance, the signal area spreads creating side lobes. A side lobe may indicate signal communication, but it is not the maximized receive power level or *peak* signal. Peaking at the maximized receive power level requires constant observance of the Received Signal Strength Indicator (RSSI) values displaying on the laptop as you scan the radios. When peaking radios, look for the lowest RSSI value, go past it, and then go back to the lowest value. Going past the low RSSI value and then going back to the low value will ensure that you have locked onto the peak signal. After verifying that you are aligned to the *peak* signal, begin locking down the position (tightening screws). When locking down the radio in peak position, the radio will move; you must observe the RSSI peak indicator value

while locking down the radio so that you can adjust the radio back to its peak position and maintain radio alignment.

When peaking radios, begin peaking radios in the horizontal position; after locking down the horizontal position (tightening screws on pole mounting assembly); then peak and lock down radios in the vertical position (tightening screws on U-clamp).

Tip:

For short distance links, use a power absorber to help determine transmit power levels. Transmit power levels may vary based on distance. Always refer to the Tx Power Specifications that come with each radio. See “[Example transmitter power specifications](#)” on page 75.

3.9.2 Configuring radio for alignment via telnet/hyperterminal session

1 Connect laptop to radio.

a If you are communicating via hyperterminal, connect laptop using a or DB9, female-to-female cable to the serial port. You do not need an IP address when using this type of connection.

b Set CLI serial port settings, if using hyperterminal:

- 19,200 kbps
- 8 data bits
- no parity
- 1 stop bit
- no flow control
- vt100 terminal emulation

c If you are communicating via telnet, connect laptop using a male-to-male RJ45 crossover cable with an RJ45 connector to the Ethernet port on radio. The radio IP address is needed when using this method.

For telneting, the laptop IP address must be different address from the radio IP address, but within the same range, for example, if the radio IP address is 192.168.1.001, the laptop IP address could be set to 192.168.1.002. (The default radio IP address is 192.168.1.230.)

2 Ping to verify radio connectivity.

3 Open a telnet or hyperterminal session.

4 Type the default user name at the prompt: **admin**

5 Type the default password at the login prompt: **password**.

Example CLI prompt:

```
GVFR#
```

6 Type `conf` at the prompt (configure terminal) to enter terminal configuration mode.

Example: `GVFR#conf`

The prompt returns showing your directory.

`GVFR(config)#`

7 Calculate power levels for radios, factory default power setting is 10 dB.

- a On the Power Calculator Utility Tool, choose spread sheet tab that matches your radio frequency, either 73.5GHz or 83.5GHz.
- b Enter the link distance (feet, miles, or kilometers).
- c Round the Pout Tx module value from the spreadsheet up or down. When rounding values, consider the receiver Antenna W/G port value to ensure rounding does not cause this value to exceed 20 dBm. It is better to round downward if Pout Tx value is close to this limit.

Tip:



Try setting power level to the lowest specified value on the spec sheet that comes with the radio when peaking. Upon peaking, increase the power level to the optimal power level (radio can easily recover from disruption). This method will help you to peak radios because the power level is less saturated at the lower value. This method will also ensure that you get the best alignment and signal strength with the lowest power reading.

Warning: Radio damage



Do not exceed **20 dBm** Antenna Port power levels as this power level or higher will damage radio receivers.

- d Using the rounded PoutTx Value, refer to this same value under the *Power Level* column on the Transmitter Power chart that came with the radio. Follow the line of the PoutTx Value to the Dac A and Dac B columns to determine those power levels see “[Example transmitter power specifications](#)” on page 75.

Dac A	Dac B	Power Defector	Power Level
4059	4059	1216	20
1155	4059	1052	19
1105	4059	916	18
1090	4059	760	17
1030	4059	666	16
975	4059	544	15
880	4059	456	14
820	4059	398	13
690	4059	336	12
600	1400	278	11
600	1240	236	10
600	1160	172	9
600	1140	148	8
600	1120	130	7
600	1095	104	6
600	1080	94	5
600	1050	82	4
600	1010	58	3
600	950	48	2
600	900	38	1
600	850	32	0

8 Navigate to `config \ rad \ ad \ AcTxBiasDACA` to set DAC A power level. At the prompt type

- a `GVFR(config)#conf`
- b `GVFR(config)#rad`
- c `GVFR(config-rad)#ad`
- d `GVFR(config-rad-ad)#set AcTxBiasDACA {calculated value}`

Example command line with a Dac A value:

`GVFR(config-rad-ad)#set AcTxBiasDACA 600`

The prompt displays “success”.

- e Confirm Dac A value, type `GVFR(config-rad-ad)#get AcTxBiasDACA`
The value displays.

- f `GVFR (config-rad-ad)#set AcTxBiasDACB {calculated value}`

Example command line with a Dac B value:

`GVFR(config-rad-ad)#set AcTxBiasDACB 4059`

Example:
Tx Power Specification

The prompt displays “success”.

- g** Confirm Dac B value, type

```
GVFR (config-rad-ad) #get AcTxBiasDACB
```

The value displays.

- 9** Peak radios, at the prompt type the following:

- a** `GVFR (config-rad-ad) #rssi_graph`

As the antenna moves, the values on the laptop will constantly change.

- b** Align radio to lowest RSSI value on Transmitter Power Chart.
See [Table A-1, “Transmitter Power Example,”](#) on page 75.

Using the referenced chart, this radio would be aligned to an RSSI value of 557.

- c** Begin aligning radio while observing RSSI values on laptop as you align radio or person on opposite link reads RSSI values as you align radio.

- d** Horizontally align radio and slowly tighten mounting assembly on pole while observing the lowest RSSI value on the laptop.

- e** Adjust radio position as necessary to maintain link on the lowest RSSI value.

- f** Vertically align radio and slowly tighten U-clamp to pole while observing the Peak RSSI value on the laptop.

- g** Press the `esc` key to exit RSSI graph mode.

- 10** Navigate up to config directory. (Type `up` at each level until you reach this directory).

- 11** Save configuration to flash memory. At the prompt type

a `GVFR (config) #conf`

b `GVFR (config-Conf) #misc`

c `GVFR (config-Conf) #set save on`

The message displays, `success set to on`

- 12** Type `quit` to end telnet or hyperterminal session.

Received Signal Level	Relative Power Indicator
-30	557
-35	583
-40	584
-45	625
-50	654
-55	688
-60	737
No Signal	>1200

Example:

RSSI Specification

3.9.3 Configuring radio for alignment via WiFiber Install application

The WiFiber Installer is a user-friendly application available when connecting to radios using the serial port connection and supports commissioning of radios. “[About the WiFiber Installer Console](#)” on page 120.

- 1** Connect laptop to radio.

If you are communicating via hyperterminal, connect laptop using a DB9, female-to-female cable to the serial port. You do not need an IP address when using this type of connection.

- 2** Launch the WiFiber Install Console application (see “[Installing the WiFiber Installer Console application](#)” on page 120).

The Main screen displays. The fields on the main screen will be blank until the application is configured for the radio. Refer to this screen throughout the peaking process for an overview of pertinent data such as Costas Lock, LVAI and LVAQ.

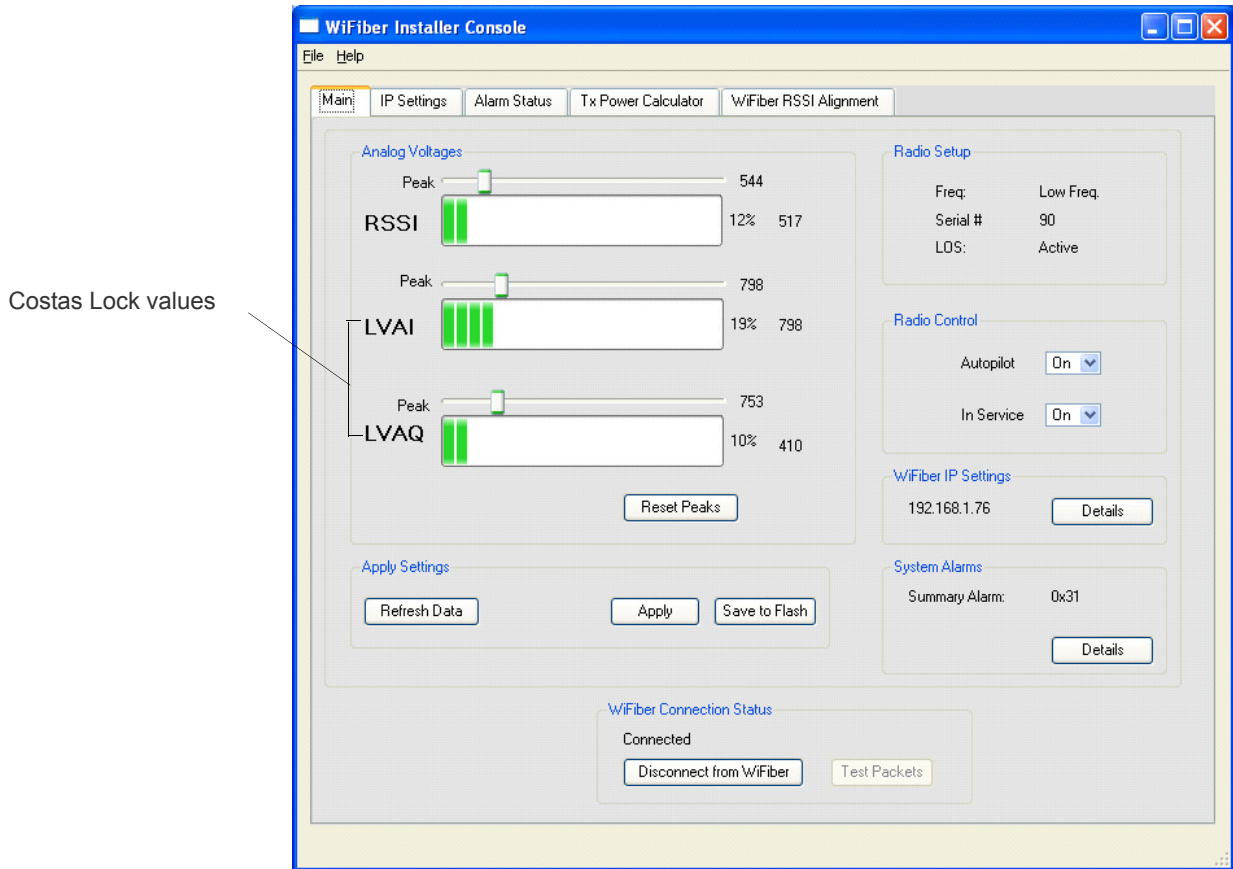

- 3 Configure WiFiber Installer Console for serial port communications.
 - a Click **File > Open**.

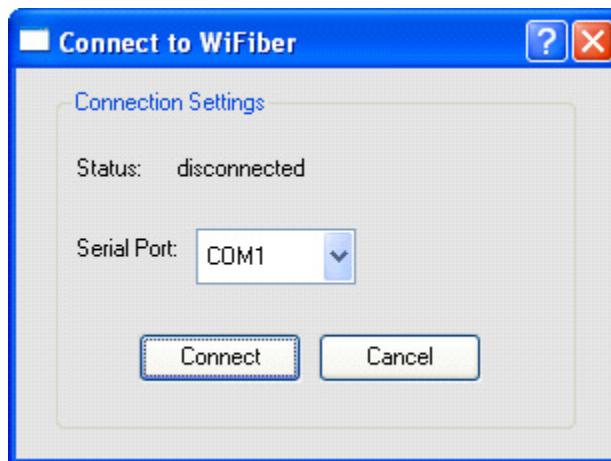

- b Under Serial Port, select the appropriate port from the list and click **Connect**. The default is COM1.
If the connection fails, check the following:

- ❑ Check cable connections: DB9, female-to-female cable connection from laptop to radio serial port.
- ❑ Check the serial port on the laptop to ensure it is not open by another application such as Hyperterminal.
- ❑ Try another COM port in the WiFiber Installer Console.
- ❑ Verify the radio is currently operational.
- ❑ After checking above items, press **Connect**.

4 Select the **Tx Power Calculator** tab.

- a Enter the link distance (feet) and click **Compute Pout TxModule**.

Warning: Radio damage



Do not exceed **20 dBm** Antenna Port power levels as this power level or higher will damage radio receivers.

Dac A	Dac B	Power Detector	Power Level
4059	4059	1210	20
1155	4059	1052	19
1105	4059	916	18
1090	4059	760	17
1030	4059	666	16
975	4059	544	15
880	4059	456	14
820	4059	398	13
690	4059	336	12
600	1400	278	11
600	1240	256	10
600	1160	172	9
600	1140	148	8
600	1120	130	7
600	1095	104	6
600	1080	94	5
600	1050	82	4
600	1010	58	3
600	960	48	2
600	900	36	1
600	850	32	0

Example:
Tx Power Specification

Received Signal Level	Relative Power Indicator
-30	557
-35	563
-40	584
-45	625
-50	654
-55	688
-60	737
No Signal	>1200

Example:
RSSI Specification

- b Using the PoutTx Value, refer to this same value under the *Power Level* column on the Tx Power Specification chart that came with the radio. Follow the line of the PoutTx Value to the *Dac A* and *Dac B* columns to determine those power levels see “[Example transmitter power specifications](#)” on page 75.

5 Select the **RSSI Alignment** tab and the following screen displays.

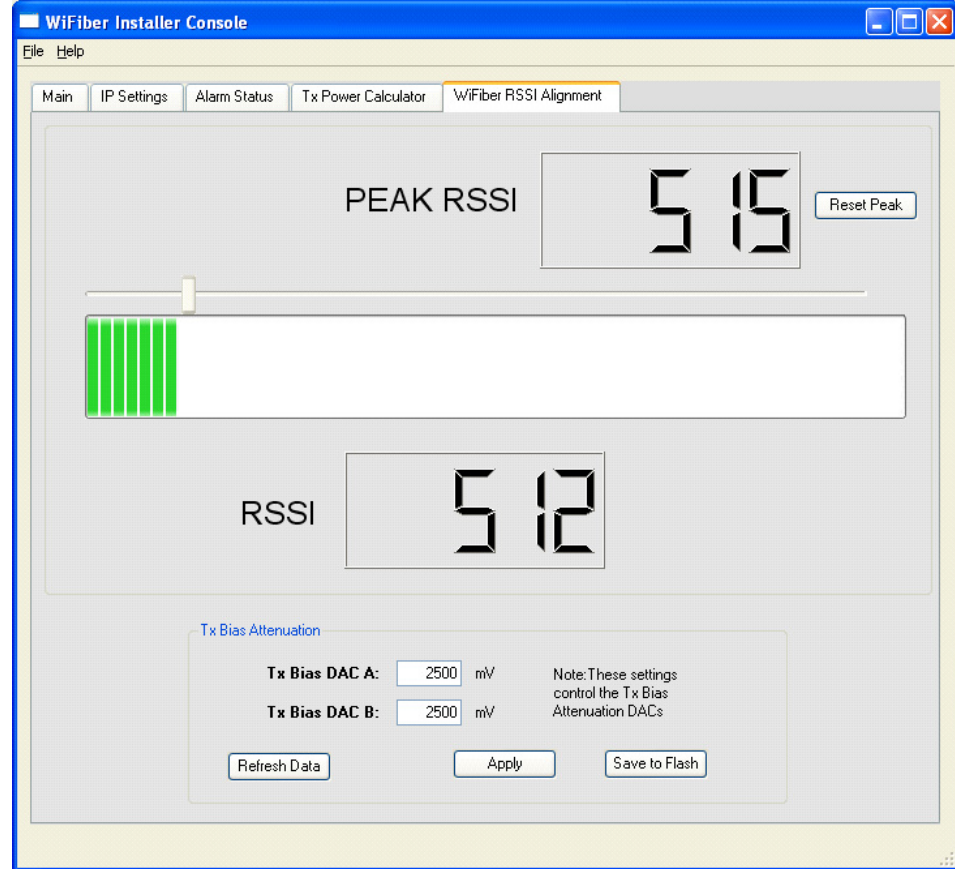

- a Enter the Tx Bias DAC A value based on the Tx Power Calculator tab and the Tx Power specifications that came with the radio.
- b Enter the Tx Bias DAC B value based on the Tx Power Calculator tab and the Tx Power specifications that came with the radio. Click **Apply**.

Warning: Radio damage



Do not exceed **20 dBm** Antenna Port power levels as this power level or higher will damage radio receivers.

- c Begin aligning radio to lowest RSSI value on Transmitter Power Chart. Using the referenced chart, this radio would be aligned to an RSSI value of 557. See [Table A-1, “Transmitter Power Example,”](#) on page 75. As you move the antenna, observe the RSSI values appearing on the RSSI Alignment screen, the RSSI values will constantly change.

Tip:

Select the **Main** tab for Costas Lock and the **Alarm Status** tab for additional information to help peak radios.

- d** Horizontally align radio and slowly tighten mounting assembly on pole while observing the lowest RSSI value on the laptop.
 - e** Adjust radio position as necessary to maintain link on the lowest RSSI value.
 - f** Vertically align radio and slowly tighten U-clamp to pole while observing the Peak RSSI value on the laptop.
 - g** On the Main tab, verify Costas Lock.
 - h** After verifying radios are peaked to peak RSSI signal and radios have Costas Lock, click **Apply** and then **Save** to save the configuration to the radio.
- 6** Exit the WiFiber Install application, click **Disconnect from WiFiber**, and then validate the radio configuration via a telnet or hyperterminal session.

3.9.4 Validating radio configuration

- 1** Open a telnet or hyperterminal session.
- 2** Login at the prompt, enter user name (**admin**) and password (**password**).
- 3** Do a soft radio reboot to verify configuration.
 - a** `gvfr(config)#c t`
 - b** `gvfr(config)#async`
 - c** `gvfr(config-async)#reboot`
The radio reboots.
- 4** Open another telnet or hyperterminal session.
- 5** Login at the prompt, enter user name (**admin**) and password (**password**).
- 6** Type **c t** at the prompt to enter terminal configuration mode.
- 7** Verify Dac A setting is the value you set it to, type
 - a** `GVFR(config)#conf`
 - b** `GVFR(config)#rad`
 - c** `GVFR(config-rad)#ad`
 - d** `GVFR(config-rad-ad)#get AcTxBiasDACA`
The value appears at the prompt.
- 8** Verify Dac B setting is the value you originally set.
 - a** Type **up** to move up one level in the directory, and then type
 - b** `GVFR(config-rad-ad)#get AcTxBiasDACB`
The value appears at the prompt.
- 9** Verify the set RSSI value is the lowest RSSI value obtained when peaking.
 - a** Type **up** to move up one level in the directory, and then type
 - b** `GVFR(config-rad-ad)#get AsRssi`

The value appears at the prompt.

- 10 If any of these values are inconsistent with the configuration settings you set during commissioning, you may need to continue peaking radios.
- 11 If values are consistent with what you configured, configuring radios is complete and the date and time stamp must be updated to complete the radio installation.

3.9.5 Setting radio date and time

A view log is available for remote network management. This log is helpful when monitoring or troubleshooting radios. In order for the view log to be accurate, the default date and time must be set.

- 1 Login as an Admin user.
- 2 Navigate to `GVFR(config-conf-async)#set datetime {MM:DD:YYYY:HH:MM:ZZZ}`
The message displays, `success set to {new date and time}`
- 3 `GVFR(config-conf-async)#set time {time}`
- 4 Save the date and time stamp to flash memory. At the prompt type
 - a `GVFR(config)#conf`
 - b `GVFR(config-Conf)#misc`
 - c `GVFR(config-Conf)#set save on`
The message displays, `success set to on`
- 5 Type `quit` to end telnet or hyperterminal session.
- 6 Disconnect laptop from radio:
 - If serial port was used, replace serial port protector to ensure radio is sealed from environmental elements.
 - If Ethernet port was used, replace Ethernet cable.
- 7 Verify all radio connectors are tight and sealed.
- 8 Secure all cabling.
- 9 Complete and file the As-Built list.

3.9.6 Testing radio installation

To ensure proper operation of radio, proceed as follows:

- 1 Connect Optical Fiber cable (LC connector) to Optical Fiber port on radio.
- 2 Put in a loopback plug at one link, an optical test set at the other link and run data.

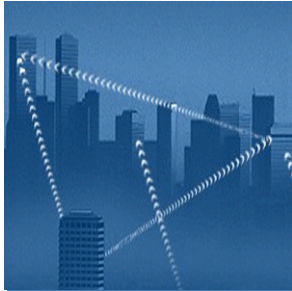

Chapter 4

Operations

This chapter provides basic information about the Command Line Interface (CLI) application to help you access, configure, and set-up a radio after installation. Topics discussed in this chapter are as follows:

- “About the CLI” on page 32
- “Logging in” on page 32
- “Navigating the CLI tree” on page 32
- “Setting up” on page 34
- “Connecting to radios remotely” on page 35
- “Common radio commands” on page 37

4.1 About the CLI

The CLI application allows you to configure the WiFiber G1.25 radio through a serial console device with hyperterminal or equivalent software or communicate directly to the device through SSH (Secure Shell). The CLI application is modeled after the Cisco IOS. The application follows a hierarchical tree structure with branches and leaf modes. The branches are objects with leaf modes that have *get*, *set*, and *log* commands. The *get* command lets you query the various objects, the *set* command allows you to assign new values to the objects, and the *log* command allows you enable or disable log objects.

4.2 Logging in

After configuring the CLI serial port settings, access the CLI through the Hyperterminal. Only five CLI sessions may be open at a given time. An error will display if additional persons try to open a CLI session after reaching this limit.

- 1 Enter the user name and password at the login prompt. The CLI prompt appears.

```
1. GVFR#
```

After logging in you must enter the terminal configuration mode.

- 2 Type `c t` at the prompt to configure terminal.

Example:

```
1. GVFR#c t
2. GVFR(config)#
```

Log in is complete and you are ready to work in the CLI application.

4.2.1 About user privileges

There are two valid user names each having different privileges: `admin` and `ruser`.

- An `admin` user has privileges to configure radio features as well as full access to configure CLI tree objects.
- The `ruser` is a restricted user with limited access to the CLI tree and does not have set access to any objects.

The default password for both user names is `password`.

CAUTION: Security Vulnerability



After installation and setup, the default password should immediately be changed to avoid security risks (see *“Managing passwords” on page 46*).

4.3 Navigating the CLI tree

All navigation in the CLI application is done at the command prompt and entered at the keyboard. You can navigate the CLI tree by typing the name of the branch or object. After you navigate through the object sub-levels where there are no more sub-

levels you have reached a leaf mode. The leaf modes contain *get* and sometimes *set* commands, which allows you to view or change the value of an object.

Table 4-2 lists common commands for navigating the CLI tree.

Table 4-2 CLI Common Navigation Commands

Command	Function
?	Lists available sub-modes for command object.
help	Lists available commands for sub mode.
set ? get ?	Lists <i>set</i> objects available for sub mode or command. Lists <i>get</i> objects available for sub mode or command.
quit	Disconnects and closes radio session.
get	Displays the value of tree object.
set	Changes value of tree object.
up	Navigates up one level in tree directory.
↑	Displays available history commands.
esc key	Exits an object mode.

Navigation example:

```
GVFR# c t (shortcut for configuring terminal)
GVFR(config)# ?
    help                Show available commands
    quit                Disconnect
    history             Show a list of previously run commands
    Sfp                 SFP Subtree
    Rad                 RAD Subtree
    Stat               STATUS Subtree
    Conf               CONFIG Subtree
    Diag               DIAGNOSTICS Subtree
GVFR(config)# sfp
GVFR(config-Sfp)# sfp1
GVFR(config-Sfp-Sfp1)# up
GVFR(config-Sfp)#
```

4.3.1 Setting integer, IP address, and string objects

To set these object values, use the following syntax:

```
set <object><value>
```

Example:

```
set RadiusIP 192.168.1.55
set radiusEnable 1
set RadiusSharedSecret 123abc
```

4.3.2 Setting enumerated integer objects (short-cut)

There are two ways to set an enumerated integer object:

- using a shortcut integer, or
- entering a command string.

Shortcut Example:

```
GVFR(config-Sfp-Sfp1-Trap) # set RxPowerLoWaTrEnable ?
```

The screen displays:

```
off(0) (zero)
on(1)
```

You can achieve the same action using one of the four command strings to set the value as shown in the following example.

Command String Examples:

```
1.GVFR(config-Sfp-Sfp1-Trap) # set RxPowerLoWaTrEnable off
2.GVFR(config-Sfp-Sfp1-Trap) # set RxPowerLoWaTrEnable 0
3.GVFR(config-Sfp-Sfp1-Trap) # set RxPowerLoWaTrEnable on
4.GVFR(config-Sfp-Sfp1-Trap) # set RxPowerLoWaTrEnable 1
```

Commands 1 and 2 are synonymous as are commands 3 and 4.

4.4 Setting up

The radio requires configuration for CLI access and communications. If you are communicating via telnet, a fixed laptop IP address is needed. If you are communicating via hyperterminal, the CLI serial port must be configured.

4.4.1 Configuring the radio IP address

To configure the radio IP address and reconfigure the Ethernet interface, at the prompt enter the following commands:

- 1 Login to the radio as an admin user through the serial interface.
- 2 `GVFR#c t`
- 3 `GVFR(config)#conf`
- 4 `GVFR(config-Conf)#ethernet`
- 5 `GVFR(config-Conf-Ethernet)#set ipaddress 192.168.1.230 (default)`
- 6 `GVFR(config-Conf-Ethernet)#set addressmask 255.255.255.0`
- 7 `GVFR(config-Conf-Ethernet)#set gateway 192.168.1.1`
- 8 `GVFR(config-Conf-Ethernet)#set reconfig 1`
Reconfiguring the IP address will disconnect your PC from the radio.
- 9 Reconnect to the radio using the new IP address.

To save the configuration to flash, continue with the following commands:

- 10 `GVFR(config-Conf-Ethernet)#up`
- 11 `GVFR(config-Conf)#misc`
- 12 `GVFR(config-Conf)#set save on`

This completes configuration of the IP address.

4.4.2 Configuring the serial port

To access the CLI through hyperterminal, configure the PC serial port to the following CLI serial port settings;

- 19200 baud
- 8 data bits
- no parity
- 1 stop bit
- no flow control
- vt100 terminal emulation

4.5 Connecting to radios remotely

Remote connections to the radios is possible using the CLI via the SSH (Secure Shell) or Telnet. This feature enables you to remotely debug the radio system.

4.5.1 Connecting via SSH

To set up an SSH remote connection

- 1 In the `config-Conf-Ethernet` mode, set the following objects to establish network connectivity:

`Address` is the IP Address,
`AddressMask` is the Subnet Mask, and the
`Gateway` is the IP address of the default gateway router.

- 2 After setting the `Address`, `AddressMask`, and `Gateway`, then set `Reconfig` to 1. This will cause the management Ethernet interface to reconfigure itself using the values that have been set for `Address`, `AddressMask` and `Gateway`.
- 3 After configuring the Ethernet port, you can use a secure shell client such as `putty` to SSH into the box with the user `wifiber@Address`. You may also choose to SSH through a command line in Linux such as: `ssh wifiber@192.168.1.100` where 192.168.1.100 is replaced with whatever you set the IP Address to in Step 1.

4.5.2 Connecting via Telnet

Remote connection is also available via the radio CLI application through the telnet port 23 after network connectivity is set up. This is not a secure connection because the user name and password are sent as clear text and can be picked up via a packet sniffer on your network.

To set up telnet session

- 1 In the `config-Conf-Ethernet` mode set the following objects to establish network connectivity:
`Address` is the IP Address,
`AddressMask` is the Subnet Mask, and the
`Gateway` is the IP address of the default gateway router.
- 2 After setting the `Address`, `AddressMask`, and `Gateway`, type
GVFR#set Reconfig 1
This will cause the management Ethernet interface to reconfigure itself using the values that have been set for `Address`, `AddressMask`, and `Gateway`.

4.5.3 Using RADIUS To Authenticate logins

Many networks co-ordinate passwords for network equipment using a RADIUS server. The radio CLI application can also authenticate against RADIUS. To do this, you must set the `RadiusIP` object to the IP address of your RADIUS server. After successfully authenticating against RADIUS, admin user privileges are given in the CLI application. This means you are able to make configuration changes.

To authenticate the radio against RADIUS

- 1 Login as an admin user and configure terminal.
- 2 Set the `RadiusIP` object to the IP address of your RADIUS server.
- 3 Set the `RadiusSharedSecret` object to your RADIUS shared secret password.
- 4 Enable the RADIUS Authentication feature, **set RadiusEnable 1**

The following example shows how to configure RADIUS authentication with a server located at 192.168.1.20 and with a shared secret of `luckycharms`:

Example configuration:

```
1. GVFR#c t
2. GVFR(config)#conf
3. GVFR(config-Conf)#async
4. GVFR(config-Conf-Async)#set RadiusIP 192.168.1.20
5. GVFR(config-Conf-Async)#set RadiusSharedSecret luckycharms
6. GVFR(config-Conf-Async)#set RadiusEnable 1
```

4.6 Common radio commands

This section describes common commands used when installing the radio.

4.6.1 Saving configurations to flash

After configuring a radio feature, it should always be saved to flash memory so that the function can be restored if needed.

To save a configuration from the configure terminal

```
1 GVFR#c t
2 GVFR(config)#conf
3 GVFR(config-Conf)#misc
4 GVFR(config-Conf)#set save on
```

4.6.2 Rebooting (soft)

It may be necessary to do a soft reboot of a radio after installation to verify a configuration.

```
1 Login as an Admin user.
2 gvfr(config)#c t
3 gvfr(config)#async
4 gvfr(config-async)#reboot
   The radio reboots.
```

4.6.3 Configuring radio power

The power transmission level must be uniquely configured for each radio as it is a function of distance between the two radios links. After calculating the correct power levels for the radio (“[Example transmitter power specifications](#)” on page 75), you are ready to configure the radio transmission power.

To configure power

- 1 Login to the CLI as an admin user .
- 2 GVFR#**c t**
- 3 GVFR(config)#**conf**
- 4 GVFR(config-Conf)#**rad**
- 5 GVFR(config-Conf-rad)#**ad**
- 6 GVFR(config-Conf-rad-ad)#**txpower**

4.6.4 Aligning radios using the RSSI graph

The `RSSI_graph` object displays a plot of the received signal strength. This is useful when aligning radios. When viewing the plot, the current value of the RSSI signal is displayed both as text and as a bar graph. The RSSI value scales between 0 and 4095. The peak value of the RSSI that is detected is displayed with the letter **P**.

To plot the receive signal strength

- 1 Login to the CLI as an admin user .
- 2 GVFR#**c t**
- 3 GVFR(config)#**rad**
- 4 GVFR(config-Rad)# **ad**
- 5 GVFR(config-Rad-Ad)#**RSSI_graph**

A radio alignment RSSI plot displays.

Example plot:

```

WiFiber Alignment RSSI plot
Press Esc key to exit..

RSSI: 1622***** P

```

- 6 Press the **Esc** key to exit.

For information on loopbacks or alarms, see [Chapter 7 “Maintenance & Troubleshooting”](#) on page 51.

4.6.5 Exiting the CLI

To ensure that you are properly logged out of the CLI application, type **quit** to exit, rather than clicking the X in the window corner. Only five (5) sessions may be open at a given time.

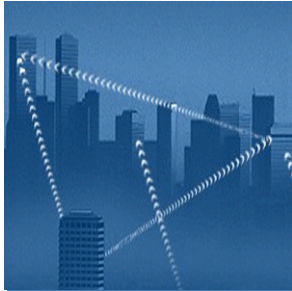

Chapter 5

Network Management

This chapter describes the Simple Network Management Protocol (SNMP) and basic operations for managing, communicating, and monitoring radios. Topics discussed in this chapter are as follows:

- “About the SNMP” on page 40
- “Setting up SNMP communications” on page 40
- “Configuring community strings and access privileges” on page 40
- “Setting-up trap receivers” on page 41
- “Managing radios using a MIB browser” on page 41

5.1 About the SNMP

The Routing Controller Module (RCM) platform contains extensive monitoring and alerting support using Simple Network Management Protocols (SNMP). The SNMP Agent on the platform supports SNMPv2c. GigaBeam provides a corresponding Management Information Base (MIB) file that is specific to the version of radio installed. See “Inventory” on page 10.

The MIB file contains the mappings between object identifiers (OID) and object text descriptions supported by the SNMP Agent. When information is sent from the RCM SNMP Agent, the MIB decodes the information sent from the RCM SNMP Agent so that it is easy to understand. Setup is required to communicate with the SNMP Agent.

5.2 Setting up SNMP communications

To communicate with the SNMP Agent on the RCM Board

- 1 Assign an IP Address to the RCM board. (See “Configuring the radio IP address” on page 35.)
- 2 Load the GigaBeam MIB file into your MIB Browser application.

5.3 Configuring community strings and access privileges

Table 5-3 describes two sets of access privileges to the SNMP tree.

Table 5-3 MIB Access Privileges

MIB Access	Default Read Community String	Default Write Community String	How to Configure
Any part of the SNMP tree except for the GbeamInstall tree. (Default)	public	public	<ol style="list-style-type: none"> 1 Login and set community strings as an <code>admin</code> user in the CLI. 2 The corresponding objects are located at <code>Conf-Snmp#ReadCommString</code> and <code>ConfSnmp#ReadWriteCommString</code>.
Only access to the GbeamInstall tree (Typically only used for the Java Configuration Manager Utility.)	install	install	Set these community strings via the CLI as an <code>admin</code> user.

5.4 Setting-up trap receivers

The traps from the RCM board can be sent to either of two trap receivers. The traps are SNMP v2 traps. On startup, the RCM board will send a ColdStart trap. The Objects used for configuration are shown below.

Table 5-4 Trap Receivers

Object	Description
TrapReceiver1 .1.3.6.1.4.1.22113.4.4.1	IP Address of the first Network Management System (NMS) that you would like to send traps to. Set the trap to your IP address, X.X.X.X, to enable sending traps to this IP.
TrapReceiver2 .1.3.6.1.4.1.22113.4.4.2	IP Address of the second NMS that you would like to send traps to. Set it to X.X.X.X to disable sending traps to this IP.

5.5 Managing radios using a MIB browser

A MIB browser is an easy-to-use tool to troubleshoot and review radio data. Using the MIB browser Walk feature, you can quickly review and update radio settings in real-time.

5.5.1 Conducting a MIB walk-thru

This procedure assumes that a MIB browser is installed on your PC and the GigaBeam MIB file is loaded into the MIB browser.

- 1 Assign the radio IP address in the MIB browser Address box.
- 2 Open the GigaBeam MIB file in the MIB browser, and select the MIB browser **Walk** feature.

Radio data displays in the MIB browser work area. The following is an example of the type of trap data that is available when performing a walk-thru.

Name/OID	Value
HwCurrentBoardRev.0	112
ConfigRev.0	1.6
PSMFuse1Alarm.0	off
PSMFuse2Alarm.0	on
PSMConverter1Alarm.0	off
PSMConverter2Alarm.0	off
SummaryAlarm.0	32
SummaryAlarmTrEnable.0	off
GroupAlarmSfp1.0	0
GroupAlarmSfp1TrEnable.0	on
GroupAlarmRad1.0	0
GroupAlarmRad1TrEnable.0	on
GroupAlarmRad2.0	0
GroupAlarmRad2TrEnable.0	on
GroupAlarmRad3.0	2048
GroupAlarmRad3TrEnable.0	on
GroupAlarmMisc.0	64
GroupAlarmMiscTrEnable.0	on
Sfp1Status.0	installed
SfpInterfaceType.0	GbE
InService.0	off
ControlLoopRadio.0	off
ControlLoopSFP1.0	off
RadiusEnable.0	disable
RadiusIP.0	0.0.0.0
RadiusSharedSecret.0	-9999
Server.0	146.145.192.37
Directory.0	/
Filename.0	kernel_rfs.rcm.image
Download.0	off
TrapIP1.0	192.168.1.6
TrapIP2.0	0.0.0.0
Save.0	on
TrapResendTimer.0	0
SelfTestConfig.0	off

A number of traps are set in this example

- 3 Select and edit an OID Value with a new value.
A screen displays allowing you to enter a new value.

Example:

The previous example shows the GroupAlarmMiscTrEnable.0 as *on*. To change the value to *off* (disable the trap), proceed as follows:

- a Select the Value for GroupAlarmMiscTrEnable.
- b Do a *Set* and enter the value 0 to disable the trap. (See the [Appendix B “CLI Quick Reference”](#) on page 77 for a list of settings for all objects.)

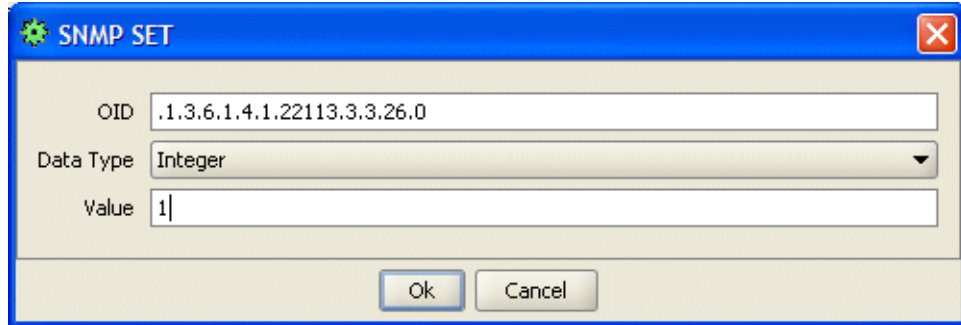

- 4 Select the Name/OID and do a *Get* to show the updated value.
- 5 After updating the MIB file, open a CLI session and save all changes to flash. This will save changes made in the MIB browser to the radio. (See [“Saving configurations to flash”](#) on page 37.).

Caution: Must save changes to radio



All changes made in a MIB browser are not saved to the radio until they are saved to flash in the CLI.



Chapter 6

Advanced Operations

This chapter describes advanced radio operations. Tasks in this section may require an understanding of the CLI, the SNMP and the Bash shell, as well as additional applications. Topics discussed in this chapter are as follows:

- “Managing passwords” on page 46
- “Managing in-band communications to radio (PPP access)” on page 46
- “Managing in-band communication link (DCC channel status)” on page 48
- “Viewing software & hardware revisions on radio” on page 48
- “Upgrading radio software” on page 48
- “Upgrading image remotely” on page 50

6.1 Managing passwords

6.1.1 Changing the admin password

The admin user default password is `password` and must be changed after the radio is installed to avoid a network security vulnerability. The admin user has privileges to access the radio CLI and to configure radio features.

- 1 Login as an admin user and type
- 2 `GVFR#c t`
- 3 `GVFR(config)#conf`
- 4 `GVFR(config-Conf)#async`
- 5 `GVFR(config-Conf-async)#set AdminPwd {new password}`
The screen displays
`success {new password}`

6.1.2 Changing the ruser password

The ruser default password is `password`. The ruser has restricted privileges with limited access to the radio CLI and cannot perform set functions.

- 1 Login as an admin user and type
- 2 `GVFR#c t`
- 3 `GVFR(config)#conf`
- 4 `GVFR(config-Conf)#async`
- 5 `GVFR(config-Conf-async)#set RuserPwd {new password}`
The screen displays
`success {new password}`

6.2 Managing in-band communications to radio (PPP access)

Peer-to-Peer (PPP) access to the WiFiber G1.25 radio will enable you to get in-band communications to the remote radio. Using PPP communications access, you can establish a CLI session, review errors, or reconfigure radio parameters on the remote radio.

CAUTION: Root Directory Access



Only persons experienced in using the WiFiber G1.25 radio and in network operations should use this procedure.

To establish PPP access

- 1 Type `telnet [target ip] 65432`
This will give you the bash shell on the radio target IP (opposite link) through port number 65432.
- 2 Login to the bash shell. The user name is `root` and the password is `alrw@v3`.
- 3 Type `ifconfig`

This command displays the root level Ethernet configuration information of the in-band IP assignments.

Note:

You may also ping the remote radio to verify the in-band connection before setting-up a telnet session. For example, if the remote radio is 10.7.4.2, you can telnet to the remote radio (using port 23).

Example:

```
bash-2.05#telnet 10.7.4.2 23
```

The PPP of the in-band radio displays. Look for the inet address that displays after ppp0 (see example below). The first inet address (10.7.4.2) is the IP address assigned to your radio for this session; the second inet address that displays after P-t-P:(10.7.4.1) is the IP address to the remote radio for this session. Use the newly assigned IP address given to the remote radio to establish a telnet session with the remote radio.

Example:

```
bash-2.05#ifconfig
eth0 Link encap:Ethernet HWaddr 00:0F:1F:7E:AB:BA
    inet addr:192.168.1.82 Bcast:192.168.1.255 Mask:255.255.255.0
    UP BROADCAST RUNNING MULTICAST MTU:1500 Metric:1
    RX packets:15982 errors:0 dropped:0 overruns:0 frame:0
    TX packets:466 errors:0 dropped:0 overruns:0 carrier:0
    collisions:0 txqueuelen:100
    RX bytes:1603819 (1.5 MiB) TX bytes:34980 (34.1 KiB)
lo Link encap:Local Loopback
    inet addr:127.0.0.1 Mask:255.0.0.0
    UP LOOPBACK RUNNING MTU:16436 Metric:1
    RX packets:0 errors:0 dropped:0 overruns:0 frame:0
    TX packets:0 errors:0 dropped:0 overruns:0 carrier:0
    collisions:0 txqueuelen:0
    RX bytes:0 (0.0 b) TX bytes:0 (0.0 b)
ppp0 Link encap:Point-to-Point Protocol
    inet addr:10.7.4.2 P-t-P:10.7.4.1 Mask:255.255.255.255
    UP POINTOPOINT RUNNING NOARP MULTICAST MTU:110 Metric:1
    RX packets:1235 errors:24 dropped:0 overruns:0 frame:0
    TX packets:1274 errors:0 dropped:0 overruns:0 carrier:0
    collisions:0 txqueuelen:3
    RX bytes:109260 (106.6 KiB) TX bytes:109357 (106.7 KiB)
```

Note:

The PPP interface to your radio has been assigned 10.7.4.2 in the above example. The remote radio has been assigned 10.7.4.1, which is the remote radio IP address for this session.

6.3 Managing in-band communication link (DCC channel status)

There is an in-band communication channel on the WiFiber G1.25 radio that is used to send status information such as the BER and FER across the radio link. This channel is distinct from the Customer data channel.

To obtain status of this DCC link, proceed as follows:

- 1 Login to the radio as admin user.
- 2 `GVFR# c t`
- 3 Navigate to `(config-Rad-Status)#get RemoteCommLinkStatus`

The screen displays the following message

```
success: 1
active
```

Tip:



When the RemoteCommLinkStatus is active, you can read the remoteBER and remoteFER in the rad-status tree to get the status of the remote side of the radio link.

6.4 Viewing software & hardware revisions on radio

To check revisions of all software and hardware loaded on a radio, proceed as follows:

- 1 Login as an Admin user.
- 2 `GVFR# c t`
- 3 Navigate to and enter the following commands:
 - a `GVFR(config-Stat-Rev)# get SwBootRev// Rev of Bootloader code`
 - b `GVFR(config-Stat-Rev)# get SwCurrentAppRev// Rev of Current App code`
 - c `GVFR(config-Stat-Rev)# get SwBackAppRev// Rev of Backup App code`
 - d `GVFR(config-Stat-Rev)# get FPGARev// Rev of FPGA Code`
 - e `GVFR(config-Stat-Rev)# get HwCurrentBoardRev// Rev of Current Board`
 - f `GVFR(config-Stat-Rev)# get ConfigRev// XML Database Configuration Revision`
 - g `GVFR(config-Stat-Rev)# get SwSynthRev// Rev of Synthesizer`

A message displays indicating success and the software or hardware revision on radio.

6.5 Upgrading radio software

There may be a need to load code to the WiFiber G1.25 radio during installation or in instances of software revisions and upgrades to existing links. Upgrading software is done using the CLI and a TFTP server application. The TFTP server application GigaBeam currently uses is SolarWinds, available at <http://www.solarwinds.net>.

The WiFiber G1.25 radio has the ability to remotely upgrade its bootloader, application image and its FPGA image using the TFTP download command. To do this upgrade, you must set up a TFTP server and configure the radio Ethernet settings. This section describes how to use the download command to upgrade either of the bootloader application or FPGA images.

To update radio software

- 1 Login to the CLI as an admin user.
- 2 `GVFR#c t`
- 3 `GVFR(config)#conf`
- 4 Navigate to `GVFR(config-Stat-Rev)` to verify current software version, and type `GVFR(config-Stat-Rev)#get swcurrentapprev`
The prompt displays the date of the last upgrade. For example,
success: Thu Jan 26 12:01:19 EST 2006
`GVFR(config-Stat-Rev)#`
- 5 Navigate back to `GVFR(config-Conf)` to begin updating software
- 6 `GVFR(config-Conf)#async`
- 7 `GVFR(config-Conf-Async)#download init`
At the prompt enter the following:
 - TFTP Server IP Address,
 - TFTP Server root directory
 - TFTP Filename

The following example describes how to update the Application image with a file named `kernelrcm.image` located in the `root(/)` directory of the TFTP server located at `192.168.1.125`:

Example:

```
GVFR(config-Conf-Async)# download init
Server IP->(0.0.0.0):192.168.1.125
TFTP Directory->( / ): (pressed enter here)
TFTP Filename->(-9999):kernelrcm.image
Are you sure?(y/n):y
cli: initiating TFTP download.. please wait
cli: download succeeded!
cli: you must commit your image by issuing the 'download commit'
command.
```

The application is now stored in RAM on the WiFiber G1.25 radio. To commit this image to flash, you must use the `download commit` command as follows:

```
GVFR(config-Conf-Async)# download commit
Commit boot, app, or fpga image?(b/a/f): a
Are you sure?(y/n): y
cli: commit of application image succeeded!
```

Note:



You can commit a boot image or an FPGA image in the same way: select **b** for boot image or **f** for FPGA image.

- 8 Verify the software upgrade. Navigate to `GVFR(config-Stat-Rev)` and type `GVFR(config-Stat-Rev)#get swcurrentapprev`
The prompt displays the date of the last upgrade. If you just updated the software, it should display the current date.

6.6 Upgrading image remotely

The radio has the ability to remotely upgrade its bootloader, application image, and the FPGA image via TFTP using the `download` command. **You must set up a TFTP server and also configure the Ethernet settings of the radio to do this upgrade.** This section describes how to use the `download` command to upgrade either of the bootloader, application image, or FPGA image.

To upgrade radio image

- 1 Login to the as an admin user
- 2 `GVFR#c t`
- 3 Navigate to `(config-Conf-Async)#`
- 4 `GVFR#(config-Conf-Async)#download init`
This initiates download of image to radio. The screen prompts you to enter the following:
 - TFTP Server IP Address
 - TFTP server root directory
 - TFTP filename.

Example:

This example describes how to update the Application image with a file named `kernelrcm.image` located in the root(/) directory of the TFTP server located at `192.168.1.125`.

```
GVFR(config-Conf-Async)# download init
Server IP->(0.0.0.0):192.168.1.125
TFTP Directory->(>): (press enter)
TFTP Filename->(-9999):kernelrcm.image
Are you sure?(y/n):y
```

The message displays:

```
cli: initiating TFTP download.. please wait
cli: download succeeded!
cli: you must commit your image by issuing the 'download commit'
command.
```

The application is currently stored in RAM on the WiFiber radio and must be saved to flash.

- 5 Save image to flash using the `download commit` command as follows:
 - a `GVFR(config-Conf-Async)# download commit`
 - b Commit boot, app, or fpga image?(b/a/f): a

c Are you sure?(y/n) : **y**

The screen displays the following message:

```
cli: commit of application image succeeded!
```

Note:



You can commit a boot image or an FPGA image in the same way by selecting either “**b**” for boot image or “**f**” for FPGA image.



Chapter 7

Maintenance & Troubleshooting

This chapter provides guidance on maintaining and resolving problems on the WiFiber G1.25 radio. Topics discussed in this chapter are as follows:

- “Maintaining unit” on page 54
- “FAQs” on page 54
- “Diagnostics” on page 55
- “Troubleshooting” on page 67

7.1 Maintaining unit

This is a self-maintained radio system that does not require servicing; a physical inspection should be done routinely to check components such as connections and mounting.

For updating radio software, see [6.5 Upgrading radio software](#), on page 48.

7.2 FAQs

This section provides guidance for diagnosing basic radio problems. If you are unable to diagnose and resolve a problem after referring to these guidelines, refer to [“Link Management Center”](#) on page xv.

Tip:



For a quick and complete overview of all radio settings, use a MIB browser. A MIB browser will allow you to review and make changes to real-time radio settings using the MIB browser walk-thru feature. (See [“Managing radios using a MIB browser”](#) on page 41.)

7.2.1 Unable to power radio

- 1 Verify LED is illuminated after allowing ~1 minute warm-up time. If LED is illuminated, the radio is powered. If LED is not illuminated, the LED may be burned out or the radio may not be powered.
- 2 Verify cables are properly connected; use volt meter to verify power cable is live.
- 3 If cable is not live, verify power supply and connections, check AC power to power supply.
- 4 If you are still unable to power radio, contact the Link Management Center.

7.2.2 Unable to communicate with radio

If you are unable to see the radio from your laptop after connecting the laptop to the radio, proceed as follows:

- 1 Verify radio is powered (LED is illuminated).
- 2 Verify cable connections from laptop to radio.
There are two ways to communicate with radios to verify the radio is on:
 - a Try telneting to the radio. Verify crossover cable, IP address, subnet, and mask (default IP address is 192.168.1.230, mask is 255.255.255.0, gateway 192.168.1.1).
 - b Try using hyperterminal to communicate with the radio. Verify console cable (DB9, female-to-female) RS232 cable. (Default is 19200 kbps, 8 data bits, no parity, 1 stop bit, no flow control, vt100 terminal emulation.)
- 3 Ping radio for response.

Dac A	Dac B	Power Detector	Power Level
4099	4059	1216	20
1195	4059	1062	19
1105	4059	916	18
1060	4059	760	17
1030	4059	666	16
975	4059	544	15
880	4059	436	14
820	4059	398	13
690	4059	336	12
600	1400	278	11
600	1240	236	10
600	1160	172	9
600	1140	148	8
600	1120	130	7
600	1095	104	6
600	1080	94	5
600	1050	82	4
600	1010	58	3
600	960	46	2
600	900	36	1
600	850	32	0

7.2.3 Lost signal

:After peaking radios and establishing a solid signal, the signal can be lost due to signal disruption, power disruption, or a radio problem.

To troubleshoot, proceed as follows

- 1 Verify radio is powered.
- 2 Telnet or console into radio.
- 3 Check for Costas Lock (`config-rad-status:#get RemoteCommLinkStatus`) to determine if radio is locked.
 If the value is not 1 (on), check the LVAI (`config-rad-ad:#get AsCostasLvaI`) and LVAQ (`config-rad-ad:#get AsCostasLvaQ`) values. These values should be a minimum of 100 points apart. The optimum value is the LVAI and LVAQ (transmit) values as stated on the radios specification sheet (refer to the Power Transmitter Specifications that came with the radio).
- 4 If transmitter signals or RSSI are incorrect, the likely cause of the lost signal is a power disruption. Peak radios in accordance with the radio Power Transmitter Specifications.

Example:
Tx Power Specification

7.3 Diagnostics

This section describes general radio diagnostics and basic procedures to help diagnose radio problems.

7.3.1 General diagnostics

The following steps provide a general guide to diagnosing a radio problem.

- 1 Check the Summary Alarm Status (`config-stat-alarm-SummaryAlarm`) and Alarm Dump (`config-stat-alarm`)#`alarm_dump`. Radio response should be `Success: 0`.
- 2 Check RSSI values (`config-Rad-Ad`)#`rss_i_graph`. Radio response should be according to radio specifications.
- 3 Check Costas Lock, LVI (`GVFR(config-Rad-Ad)#AsCostasLvaI`) and LVQ (`GVFR(config-Rad-Ad)#AsCostasLvaQ`) to determine if radios are communicating. The difference between these two values should be +100.
- 4 Check FER, BER, and link status to see if radios are taking errors. Radio response should be success 0 or a statement will display stating success. If radio is in an alarm condition a value other than (0) zero will display or a statement will display describing the alarm condition, which will help direct your next steps in troubleshooting. Check the following conditions:
 - Local FER (`GVFR(config-Rad-Status)#get LocalFER`)
 - Remote FER (`GVFR(config-Rad-Status)#get RemoteFER`)
 - Local BER(`GVFR(config-Rad-Status)#get LocalBER`)
 - Remote BER (`GVFR(config-Rad-Status)#get RemoteBER`)

- Remote Communication Link Status (GVFR(config-Rad-Status) #get RemoteCommLinkStatus)
- 5 Do a remote radio loopback to see if the radio is taking errors (see “Radio local loopback configuration” on page 70).
- 6 Do a local loop from SFP to a test set to verify optical fiber (see “SFP (customer) external loopback configuration” on page 69).

7.3.2 Obtaining an alarm status and alarm dump

An alarm status displays a quick overview of all radio alarms. To obtain an alarm status, proceed as follows:

- 1 Login to the CLI as an admin user.
- 2 Type `c t`
- 3 Navigate to `GVFR(config-Stat-Alarm) #get ?`

The screen displays a list of radio alarms. The SummaryAlarm object displays the radio alarm status. The alarms listed after the SummaryAlarm allow you to get status for a particular alarm or enable or disable traps for that specific alarm (see 7.3.3 Setting traps).

```
SummaryAlarm          [int] Card Summary Alarm Status/Bitmap
SummaryAlarmTrEnable [enum] En/Dis TRAP Summary Alarm
GroupAlarmSfp1        [int] Group Summary Alarm Status for SFP1
GroupAlarmSfp1TrEnable [enum] En/Dis TRAP Group Alarm SFP1
GroupAlarmRad1        [int] Group Summary Alarm Status for RADIO1
GroupAlarmRad1TrEnable [enum] En/Dis TRAP Group Alarm RADIO1
GroupAlarmRad2        [int] Group Summary Alarm Status for RADIO2
GroupAlarmRad2TrEnable [enum] En/Dis TRAP Group Alarm RADIO2
GroupAlarmRad3        [int] Group Summary Alarm Status for RADIO3
GroupAlarmRad3TrEnable [enum] En/Dis TRAP Group Alarm RADIO3
GroupAlarmMisc        [int] Group Summary Alarm Status for Miscellaneous
GroupAlarmMiscTrEnable [enum] En/Dis TRAP Group Miscellaneous
```

- 4 Obtain a summary of alarms, after the prompt type

```
GVFR(config-Stat-Alarm) #get summaryAlarm
```

A list of radio alarms display. The following is an example of a Summary Alarm Status.

Example:

```
GVFR(config-Stat-Alarm) # get summaryalarm
success: 0
```

A zero (0) as in this example indicates that the radio is operational and not in an alarm condition.

- Obtain an alarm dump to further investigate the radios status. After the prompt type

```
GVFR(config-Stat-Alarm)#alarm_dump
```

The following is an example of an Alarm Status Screen.

Example:

```
WiFiber Alarm Status Screen
-----
Summary Alarm: 0x00000020
GroupAlarmMisc: 0x00000040
          (bit 6) Power supply fuse 2 alarm
```

This Alarm Status example indicates a problem with the redundant power supply. When displaying an Alarm Status, if the radio is in an alarm condition, the alarm condition(s) will display.

7.3.3 Setting traps

A trap is a notification event (not necessarily an outage, a fault, or a security violation) that is available using the MIB file and MIB browser and for Network Management using the WiFiber G1.25 radio software [Chapter 5 “Network Management” on page 39](#). Traps for various alarms may be set to help diagnose a radio problem. Each trap must be set individually and may be enabled or disabled:

- off(0) - indicates the trap is disabled.
- on(1) - indicates the trap is enabled.

To set a trap

- Login to the CLI as an admin user.
- Type `c t`
- Navigate to `GVFR(config-Stat-Alarm)#get ?`

The following list of radio alarms display.

```
SummaryAlarm          [int] Card Summary Alarm Status/Bitmap
SummaryAlarmTrEnable [enum] En/Dis TRAP Summary Alarm
GroupAlarmSfp1        [int] Group Summary Alarm Status for SFP1
GroupAlarmSfp1TrEnable [enum] En/Dis TRAP Group Alarm SFP1
GroupAlarmRad1        [int] Group Summary Alarm Status for RADIO1
GroupAlarmRad1TrEnable [enum] En/Dis TRAP Group Alarm RADIO1
GroupAlarmRad2        [int] Group Summary Alarm Status for RADIO2
GroupAlarmRad2TrEnable [enum] En/Dis TRAP Group Alarm RADIO2
GroupAlarmRad3        [int] Group Summary Alarm Status for RADIO3
GroupAlarmRad3TrEnable [enum] En/Dis TRAP Group Alarm RADIO3
GroupAlarmMisc        [int] Group Summary Alarm Status for Miscellaneous
GroupAlarmMiscTrEnable [enum] En/Dis TRAP Group Miscellaneous
```

The description after each radio alarm indicates if an object can enable or disable a trap,

- Enable a trap, type `set {trap object} 1`

The following example enables a trap for GroupAlarmRad1TrEnable.

Example:

```
GVFR(config-Stat-Alarm) # set GroupAlarmSfp1TrEnable 1
```

The screen displays

```
success: set to 1
```

To disable the trap for the GroupAlarmRad1TrEnable, type

```
GVFR(config-Stat-Alarm) # set GroupAlarmSfp1TrEnable 0
```

The screen displays the following:

```
success: set to 0
```

This completes enabling or disabling a trap for a specific radio alarm. To set multiple traps, repeat the above procedure for each radio trap.

7.3.4 Enabling/disabling logs

Collecting specific data for viewing is a two step process: a log must be enabled for each object, for example, log localBER and log localFER must both be enabled. Obtaining radio vitals allow viewing of logs. Typing 1 after the object enables the log; typing 0 after the object disables the log. Logs are off or disabled by default. Log types are located in two different branches: config-rad-ad and config-rad-status.

To enable logs located in the config-rad-status branch

- 1 Login to the CLI as an admin user.
- 2 Type `c t`
- 3 Navigate to `GVFR(config-Rad-Status) #help`

The following screen displays available commands, which includes available logs.

```
help                Show available commands
quit                Disconnect
history             Show a list of previously run commands
up                  Go up one level
log LocalBER        [str] Local Bit Error Rate
log RemoteBER       [str] Bit Error Rate
log FrameSync       [enum] Radio Frame Sync
log RemoteCommLinkStatus [enum] Remote Radio Comm Link Status
log LocalFER        [str] Local Frame Error Rate
log RemoteFER       [str] Remote Frame Error Rate
log RxDataPathAlarm [enum] RX DataPath Alarm
log TxDataPathAlarm [enum] TX DataPath Alarm
log RadioSignalAlarm [enum] Radio Signal Fault Flag
log CustomerSignalAlarm [enum] Customer Signal Fault Flag
get LocalBER        [str] Local Bit Error Rate
get RemoteBER       [str] Bit Error Rate
get FrameSync       [enum] Radio Frame Sync
get RemoteCommLinkStatus [enum] Remote Radio Comm Link Status
get LocalFER        [str] Local Frame Error Rate
get RemoteFER       [str] Remote Frame Error Rate
get RxDataPathAlarm [enum] RX DataPath Alarm
get TxDataPathAlarm [enum] TX DataPath Alarm
get RadioSignalAlarm [enum] Radio Signal Fault Flag
get CustomerSignalAlarm [enum] Customer Signal Fault Flag
```

The following example describes how to enable a log for localBER.

Example:

```
GVFR(config-Rad-Status)# log localBer 1
success: log is turned on
```

To observe any radio localBER log data, see [7.3.5 Viewing logs](#).

To enable logs located in the config-rad-ad branch

- 1 Login to the CLI as an admin user.
- 2 Type `c t`
- 3 Navigate to `GVFR (config-Rad-Ad) #help`

The following screen displays available commands, which includes commands.

Commands available:

```

help                Show available commands
quit                Disconnect
history            Show a list of previously run commands
up                 Go up one level
log AsRssi         [int] Analog RSSI in mV
log AcAgc          [int] Automatic Gain Control Voltage in mV
log AcTxBiasDACA   [int] Tx Bias DAC A Setting
log AcTxBiasDACB   [int] Tx Bias DAC B Setting
log AsTxBiasADC    [int] Tx Bias ADC Setting
log AsTxTemp       [int] Radio Temp Sensor in degrees C
log AsCostasLvaI   [int] COSTAS LVA I
log AsCostasLvaQ   [int] COSTAS LVA Q
log AsCostasTune   [int] COSTAS Tuning Voltage
get AsRssi         [int] Analog RSSI in mV
get AcAgc          [int] Automatic Gain Control Voltage in mV
get AcTxBiasDACA   [int] Tx Bias DAC A Setting
get AcTxBiasDACB   [int] Tx Bias DAC B Setting
get AsTxBiasADC    [int] Tx Bias ADC Setting
get AsTxTemp       [int] Radio Temp Sensor in degrees C
get AsCostasLvaI   [int] COSTAS LVA I
get AsCostasLvaQ   [int] COSTAS LVA Q
get AsCostasTune   [int] COSTAS Tuning Voltage
set AcAgc          [int] Automatic Gain Control Voltage in mV
set AcTxBiasDACA   [int] Tx Bias DAC A Setting
set AcTxBiasDACB   [int] Tx Bias DAC B Setting
RSSI_graph         RSSI alignment graph

```

The following is an example that describes how to enable log asRSSI.

Example:

```
GVFR(config-Rad-Ad)# log asRSSI 1
success: log is turned on
```

To observe any radio localBER log data, see [7.3.5 Viewing logs](#).

7.3.5 Viewing logs

This feature allows you to view real-time radio log information as well as flash-logged values for specific objects or commands, such as Costas Lock (LVal and LVaQ values), RSSI, BERs, FERs, and RemoteCommLinkStatus. For example, if you wanted to log the value of AsRSSI over time and then view the logged values, you could enable the log for this object and then use the viewLog command to view the logged values. The viewLog is a file that can hold up to 256K of vital radio statistics. To view log data, each log object must be enabled to collect data, logs are *off* or disabled by default.

To view log values

- 1 Login to the CLI as an admin user.
- 2 Type `c t`
- 3 Navigate to `GVFR(config-conf-async)#viewLog ?`

The following screen displays.

```
GVFR(config-Conf-Async)#viewLog ?
usage: viewlog [ARG: clear, all, set, debug, vitals]
```

The available arguments (ARG) perform the following functions:

Clear - Clears records both in RAM cache and flash sector.

All - Displays debug information, set commands, and values of logging objects.

Set - Displays set commands issued by users.

Debug - Displays the debug log information.

Vitals - Displays the value of currently enabled objects.

There are two modes for viewing logged data:

With pagination (Y) - Displays one page/screen of log records at a time.

Without pagination (N) - Displays continuous log records without stopping until there are no more records.

- 4 Use the following syntax to display logs using the available viewLog arguments:

```
GVFR(config-Conf-Async)# viewLog {ARG}
```

Example:

To display viewLog vitals records, enter the following:

```
GVFR(config-Conf-Async)# viewLog vitals
```

The prompt asks if you want the radio vitals paginated. Typing Yes (y), will display a screen of data and prompt you to display the next page of data. Answering No (N) will display running data until all 256K of viewLog vital data is displayed. Press

Esc to exit viewLog and return to config-conf-async.

The following is a typical example of the first screen (or page) of viewLog vital data that displays.

```

Mon Mar 13 08:55:36 2006 RemoteCommLinkStatus 0
Mon Mar 13 08:55:36 2006 AsRssi 841
Mon Mar 13 08:55:37 2006 LocalFER 0.00e+00
Mon Mar 13 08:55:37 2006 RemoteFER 0.00e+00
Mon Mar 13 08:55:37 2006 AsCostasLvaI 804
Mon Mar 13 08:55:37 2006 AsCostasLvaQ 531
Mon Mar 13 08:55:43 2006 LocalBER 0.00e+00
Mon Mar 13 08:55:43 2006 RemoteBER 0.00e+00
Mon Mar 13 08:55:43 2006 RemoteCommLinkStatus 0
Mon Mar 13 08:55:43 2006 AsRssi 841
Mon Mar 13 08:55:43 2006 LocalFER 0.00e+00
Mon Mar 13 08:55:43 2006 RemoteFER 0.00e+00
Mon Mar 13 08:55:43 2006 AsCostasLvaI 804
Mon Mar 13 08:55:43 2006 AsCostasLvaQ 529
Mon Mar 13 08:55:50 2006 LocalBER 0.00e+00
Mon Mar 13 08:55:50 2006 RemoteBER 0.00e+00
Mon Mar 13 08:55:50 2006 RemoteCommLinkStatus 0
Mon Mar 13 08:55:50 2006 AsRssi 842
Mon Mar 13 08:55:50 2006 LocalFER 0.00e+00
Mon Mar 13 08:55:50 2006 RemoteFER 0.00e+00
Mon Mar 13 08:55:50 2006 AsCostasLvaI 804
Mon Mar 13 08:55:50 2006 AsCostasLvaQ 531
Mon Mar 13 08:55:57 2006 LocalBER 0.00e+00
Mon Mar 13 08:55:57 2006 RemoteBER 0.00e+00
Mon Mar 13 08:55:57 2006 RemoteCommLinkStatus 0
Mon Mar 13 08:55:57 2006 AsRssi 842
Mon Mar 13 08:55:57 2006 LocalFER 0.00e+00
Mon Mar 13 08:55:57 2006 RemoteFER 0.00e+00
Mon Mar 13 08:55:57 2006 AsCostasLvaI 804
Mon Mar 13 08:55:57 2006 AsCostasLvaQ 531
Mon Mar 13 08:56:03 2006 LocalBER 0.00e+00
Mon Mar 13 08:56:03 2006 RemoteBER 0.00e+00
Mon Mar 13 08:56:03 2006 RemoteCommLinkStatus 0
Mon Mar 13 08:56:04 2006 AsRssi 842
Mon Mar 13 08:56:04 2006 LocalFER 0.00e+00
Mon Mar 13 08:56:04 2006 RemoteFER 0.00e+00
Mon Mar 13 08:56:04 2006 AsCostasLvaI 804
Mon Mar 13 08:56:04 2006 AsCostasLvaQ 531
Mon Mar 13 08:56:10 2006 LocalBER 0.00e+00
Mon Mar 13 08:56:10 2006 RemoteBER 0.00e+00
Mon Mar 13 08:56:10 2006 RemoteCommLinkStatus 0
Mon Mar 13 08:56:10 2006 AsRssi 841
Mon Mar 13 08:56:10 2006 LocalFER 0.00e+00

```



Day, Date and Time Stamp **Vital Description** **Status**

7.3.6 Obtaining radio error status

Obtaining a Radio Status will help determine if a radio is taking errors.

- 1 Login to the CLI as an admin user.
- 2 Type `c t`

3 Navigate to `GVFR(config-Rad-Status)#get ?`

The following list of radio error types display.

```
LocalBER          [str] Local Bit Error Rate
RemoteBER         [str] Bit Error Rate
FrameSync         [enum] Radio Frame Sync
RemoteCommLinkStatus [enum] RemoteRadioCommLinkStatus
LocalFER          [str] Local Frame Error Rate
RemoteFER         [str] Remote Frame Error Rate
RxDataPathAlarm  [enum] RX DataPath Alarm
TxDataPathAlarm  [enum] TX DataPath Alarm
RadioSignalAlarm [enum] Radio Signal Fault Flag
CustomerSignalAlarm [enum] Customer Signal Fault Flag
```

The primary errors to observe are the LocalBER, RemoteBER, LocalFER, and RemoteFER, FrameSync, and RemoteCommLinkStatus.

The following example describes how to check LocalBER to determine if the radio is taking errors.

Example:

```
GVFR(config-Rad-Status)#get LocalBER
```

An example of a screen display is as follows:

```
success: 0.00e+00
```

This example indicates that there are no LocalBER errors. If the radio was taking errors, a statement would appear indicating an error, which would indicate further investigation is required.

7.3.7 Verifying RSSI values

To verify your receive signal strength, verify the real-time RSSI values.

- 1** Login to the CLI as an admin user.
- 2** Type `c t`

3 Navigate to `GVFR(config-Rad)#?`

The following screen displays. The most useful selections for troubleshooting are Status and Ad. Status will give radio status of local and remote BER and FER, while Ad will give you real-time radio analog readings.

```
GVFR(config-Rad)#
help                Show available commands
quit                Disconnect
history            Show a list of previously run commands
up                 Go up one level
Base                RADIO BASE CONFIGURATION
Ext                RADIO EXTENDED BASE CONFIGURATION
Thres              RADIO THRESHOLD CONFIGURATION
Diag               RADIO REALTIME READINGS
Status             RADIO LOCAL & REMOTE STATUS
Control            RADIO CONTROL CONFIGURATION
Flag               RADIO FLAG STATUS
Ad                 RADIO ANALOG INTERFACE CONFIGURATION
Ds                 RADIO DIGITAL SENSE STATUS
Trap               RADIO TRAP CONFIGURATION
```

4 Navigate to `GVFR(config-Rad)# ad`**5** `GVFR(config-Rad-Ad)# ?`

The following screen displays:

```
help                Show available commands
quit                Disconnect
histor              Show a list of previously run commands
up                 Go up one level
get                 get an object's value
set                 set an object's value
RSSI_graph          RSSI alignment graph
```

The `RSSI_graph` displays real-time RSSI values. This may also be displayed in the MIB browser. This is useful when monitoring or aligning radios.

6 Display real-time RSSI values, at the prompt type

```
GVFR(config-Rad-Ad)# rss_i_graph
```

The following is an example of real-time RSSI values (the value is constantly updating during a live session).

```
WiFiber Alignment RSSI plot
Press Esc key to exit..
RSSI: 557 *****P
```

These values should be close to the radio specifications that came with your radio. If the RSSI value is not close to radio specifications, check for Costas Lock. If the RSSI value is low, it indicates the radio is getting too much power. If the RSSI value is high, the radio may not be getting enough power or is experiencing environmental problems such as interference.

If you are unable to resolve the RSSI problem, do a MIB walk-thru to view real-time radio values in detail. The following figure illustrates a portion of the data that displays when doing a MIB walk-thru.

Name/OID	Value	
CostasLock.0	Inactive	
DsSynthOk.0	Inactive	
CostasLoopLock.0	Inactive	
TxDataPath.0	Inactive	
RxDataPath.0	Inactive	
RadioSignal.0	Inactive	
CustomerSignal.0	Inactive	
DsRadioPresence.0	Inactive	
AsRssi.0	721	← RSSI values
AcAgc.0	800	
AcTxBiasDACA.0	1055	
AcTxBiasDACB.0	4059	← Costas Lock
AsTxBiasADC.0	656	
AsTxTemp.0	37	
AsCostasLvaI.0	704	← I value and
AsCostasLvaQ.0	427	← Q value
AsCostasTune.0	3803	
DsSynthOK.0	on	
DsCostasLock.0	off	
DsRadioPresence.0	on	
DsCostasLoopLock.0	on	
TempHiAlTrEnable.0	off	
TempLoAlTrEnable.0	off	
TempHiWaTrEnable.0	off	
TempLoWaTrEnable.0	off	
SwBootRev.0	1.0.2 (Oct 27 2005)17:18:14	
SwCurrentAppRev.0	Thu Jan 26 12:01:19 EST 2006	
SwBackupAppRev.0	RCM 01/26/2006 12:04:34 PM	

Figure 7-10 Example of a MIB walk-thru of RSSI readings showing LVal, LVaQ and verifies Costas Lock.

7.3.8 Checking Costas Lock to verify link communications

Radios depend on a Costas Lock for successful communications. Without Costas Lock, the radios are not communicating. Radio Costas Lock can be verified by looking at real-time analog data on a radio (config-Rad-Ad). Under config-Rad-Ad are commands AsCostasLVal and ASCosatasLvaQ, which are used to determine Costas Lock and will be referred to as LVal and LVaQ. Querying the values of LVal and LVaQ and calculating the variation between these two values will indicate if the radios have Costas Lock. Typically, variation between LVal and LVaQ is greater than 100 and should be close to radio Tx Power Specifications. Each side of the link must be tested for Costas Lock. If you determine a radio does not have Costas Lock after aligning radios and verifying Costas Lock, contact the Link Management Center.

To check the radio for Costas Lock

- 1 Login to the CLI as an admin user.
- 2 Type `c t`
- 3 Navigate to `GVFR(config-Rad-Ad) #get ?`

The following screen displays.

```
AsRssi                [int] Analog RSSI in mV
AcAgc                 [int] Automatic Gain Control Voltage in mV
AcTxBiasDACA          [int] Tx Bias DAC A Setting
AcTxBiasDACB          [int] Tx Bias DAC B Setting
AsTxBiasADC           [int] Tx Bias ADC Setting
AsTxTemp              [int] Radio Temp Sensor in degrees C
AsCostasLvaI          [int] COSTAS LVA I--- Costas Loop I value
AsCostasLvaQ          [int] COSTAS LVA Q--Costas Loop Q value
AsCostasTune          [int] COSTAS Tuning Voltage
```

- 4 Check for Costas Lock, at the prompt type,
`GVFR(config-Rad-Ad) #get AsCostasLvaI`

The screen displays the following:

```
success:800
```

```
GVFR(config-Rad-Ad) #get AsCostasLvaQ
```

The screen displays the following:

```
success:459
```

The difference between I and Q is 341 points, which would indicate the radio has Costas Lock (both sides of a link must be checked).

- 5 Confirm radio links are communicating, verify Remote Comm Link Status.

- a Navigate to `(config-Rad-Status)` and type.
- b `GVFR(config-Rad-Status) #get RemoteCommLinkStatus`
The screen displays 1 if radios are communicating.

7.3.9 Verifying optical link

Obtaining an Sfp Status will provide the optical fiber status for a link.

To obtain status

- 1 Login to the CLI as an admin user.
- 2 Type `c t`
- 3 Navigate to `GVFR(config-Stat-sfp) #get ?`

The screen displays the following:

```
Sfp1Status            [enum] SFP1 Status
SfpInterfaceType      [enum] SFP Interface Type
```

The Sfp1Status object gives a complete status of the optical fiber.

The SfpInterfaceType object describes the type of Ethernet, for example GbE indicates a Gigabit Ethernet.

- 4 Obtain an Sfp status, type `GVFR(config-Stat-sfp)#get sfp1Status`
The following is an example of an Sfp Status that displays on the screen.

Example:

```
GVFR(config-Stat-Sfp)# get sfp1Status
success: 0
installed
```

The 0 indicates that there are currently no signal errors.

- 5 To further investigate, navigate to `config-Sfp-Sfp1-Ad`, and display objects.

```
GVFR(config-Sfp-Sfp1-Ad)# get ?
```

The screen displays a complete status of the Sfp1 Ad (analog Data):

```
Temp                [int] Measured Temperature (Scaled in C)
Vcc                 [int] Measured Voltage in mV
TxBias             [int] Measured Tx Bias Current in mA
TxPower            [int] Measured Tx Output Power in uW
RxPower            [int] Measured Rx Output Power in uW
SignalErr          [enum] Signal Alarm Status for SFP1
```

When considering the Sfp1 Ad, check for the following:

Temp - this indicates if the radio is overheating (power is too high).is screen,
RxPower and TxPower - these values should be close. If they are not, it could
indicate a problem passing traffic.

- 6 Check to see if the radio is taking errors, type.

```
GVFR(config-Sfp-Sfp1-Ad)# get SignalErr
```

The following is an example of a SignalErr report that displays on the screen:

```
success: 0
Inactive
```

The above display indicates that there are currently no signal errors.

Tip:



To check the fiber for polarization, check the Rx power [`(config-sfp-sfp1-ad)#get TxPower`] and Tx power [`(config-sfp-sfp1-ad)#getRxPower`] level. The RX and TX values are normally close. If there is no Rx signal on a new install, check the cable for polarization.

7.4 Troubleshooting

This section describes general trouble shooting guidelines as well as how to configure loopbacks. Using an MIB browser for a complete, quick overview may be helpful. A MIB browser will allow you to review and make changes to real-time radio settings using the MIB browser Walk feature. (See “[Managing radios using a MIB browser](#)” on page 41.)

7.4.1 General troubleshooting

When troubleshooting a link problem begin checking the following:

- 1 Test communication links between radios (local loopback).
- 2 If there is a communications problem, and the RSSI is high, check Costas Lock and the environment for interference.
If the RSSI is low and the variation between Costas Lock LVaI and LVaQ values are less than 100, radios may not be aligned or there may be a hardware problem. If it is a hardware problem, contact the Link Operations Management Center.
- 3 Check SFP (SFP loopback). This will help to determine if SFP and fiber are good between the radio and customer equipment.
- 4 Check radios (radio loopback). This loopback will look at all components between the remote radio and your radio.
- 5 Check equipment and configuration.

If you are still unable to resolve the problem, contact the Link Operations Management Center.

7.4.2 Configuring loopbacks

There are three separate loopback configurations available to help troubleshoot and diagnose radio problems. Loopback configuration objects are located in the config-conf-Control tree and each have *get/set* functions:

- Radio External Loopback, ControlLoopRadio object
- Customer External Loopback, ControlLoopSFP1 object
- Radio Local Loopback. DebugLoop object
- SFP Radio local loopback configuration, ControlLoopRadioLocal object

7.4.2.1 Activating/deactivating loopback mode

The InService object located in the config-conf-Control tree, enables and disables loopback functionality. It must be set to `off` when the loopbacks are being exercised.

CAUTION:



The InService object only applies when loopback testing is performed. After completing loopback testing, the InService object must be turned back to `on` for the radio system to work properly.

7.4.2.2 Radio external loopback configuration

The following figure illustrates the Radio External Loopback configuration, which is also known as Customer Local Loopback. This loop will verify connectivity from remote radio to the test equipment at the local demarcation point.



Figure 7-11 Radio External Loopback / Customer Local Loopback Configuration.

To loopback the external radio interface

- 1 Login to the CLI as an admin user.
- 2 `GVFR#c t`
- 3 `GVFR(config)#conf`
- 4 `GVFR(config-Conf)#control`
- 5 `GVFR(config-Conf-Control)#set InService off`
- 6 `GVFR(config-Conf-Control)#set controlloopradio on`

To turn the external radio loopback off and bring the radio back into service, type

- 7 `GVFR(config-Conf-Control)#set controlloopradio off`
- 8 `GVFR(config-Conf-Control)#set InService on`

7.4.2.3 SFP (customer) external loopback configuration

The following figure illustrates a Small Form-Factor Pluggable (SFP) Customer External loopback. This will verify fiber in the SFP and the radio to point of demarcation.

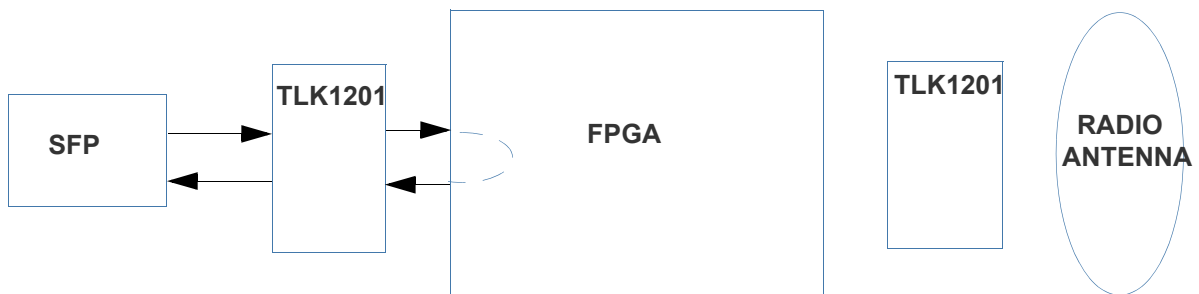

Figure 7-12 SFP (Customer) External Loopback path.

To loopback the external SFP (customer) interface

- 1 Login to the CLI as an admin user.
- 2 GVFR#**c t**
- 3 GVFR(config)#**conf**
- 4 GVFR(config-Conf)#**control**
- 5 GVFR(config-Conf-Control)#**set InService off**
- 6 GVFR(config-Conf-Control)#**set controlloopsfp1 on**

To turn the SFP (Customer) loopback off and bring the radio back into service, type

- 7 GVFR(config-Conf-Control)#**set controlloopsfp1 off**
- 8 GVFR(config-Conf-Control)#**set InService on**

7.4.2.4 Radio local loopback configuration

The following figure illustrates the Radio Local Loopback configuration. This loop will verify from the test set at the local demarcation to local radio.

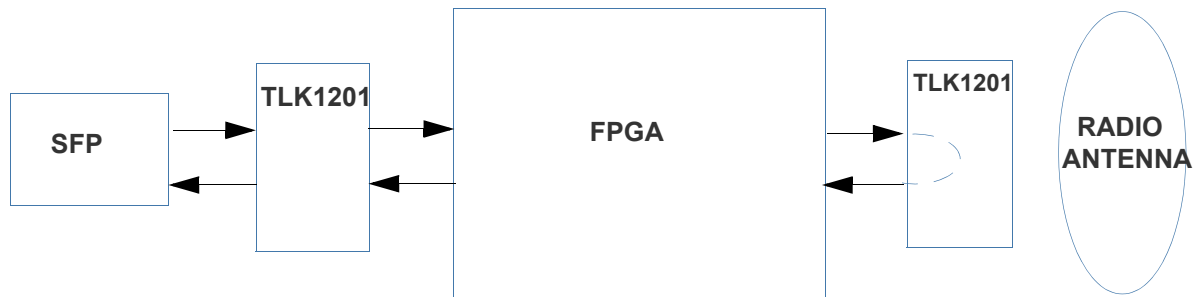

Figure 7-13 Radio Local Loopback configuration.

To configure to radio local loopback

- 1 Login to the CLI as an admin user.
- 2 GVFR#**c t**
- 3 GVFR(config)#**conf**
- 4 GVFR(config-Conf)#**control**
- 5 GVFR(config-Conf-Control)#**set InService off**
- 6 GVFR(config-Conf-Control)#**set ControlLoopRadioLocal on**

To turn the external SFP loopback off and bring the radio back into service, type

- 7 GVFR(config-Conf-Control)#**set ControlLoopRadioLocal off**
- 8 GVFR(config-Conf-Control)#**set InService on**

7.4.2.5 Debugging loopback configurations

The `DebugLoop` object is another way to configure loopbacks. This object is a bitmap (defined in following table), which maps directly to the loopback control register of the FPGA.

Table 7-5 Debugging Loopback Object Bitmap Description

Bit(s)	Name	Description
0:4	Reserved	Not Used
5	Radio local loopback	1 == Enable local loopback path in radio transceiver
6	Customer local loopback	1 == Enable local loopback in customer transceiver
7:11	Reserved	
12	FPGA All Zero Output	1 == Output all zeros from FPGA
13	Radio external loopback	1 == Reflect incoming data at the customer interface
14	SFP (Customer) external loopback	1 == Reflect incoming data at the customer interface
15	N/A	N/A

To debug a loopback configuration using the `DebugLoop` object.

- 1 Login to the CLI as an admin user.
- 2 `GVFR#c t`
- 3 `GVFR(config)#conf`
- 4 `GVFR(config-Conf)#control`
- 5 `GVFR(config-Conf-Control)#set InService off`
- 6 `GVFR(config-Conf-Control)#set debugloop 0x0002`
 Setting `debugloop` to `0x0002` will enable the SFP (customer) external loopback. The MSB of `DebugLoop` corresponds to bit 0 of the FPGA register.

Important:
 When the `debugloop` object is not `0`, this object will override the settings of the `ControlLoopRadio` and `ControlLoopSFP1` objects.

- 7 `GVFR(config-Conf-Control)#set InService on`

7.4.2.6 Radio to SFP local loopback configuration

The following figure illustrates the SFP local loopback configuration. This loop will verify the radio to SFP on the local side to the test set.



Figure 7-14 Radio to SFP Local Loopback path.

To loopback the local SFP to radio

- 1 Login to the CLI as an admin user.
- 2 `GVFR#c t`
- 3 `GVFR(config)#conf`
- 4 `GVFR(config-Conf)#control`
- 5 `GVFR(config-Conf-Control)#set InService off`
- 6 `GVFR(config-Conf-Control)#set ControlLoopRadioLocal on`

To turn the SFP (Customer) loopback off and bring the radio back into service, type

- 7 `GVFR(config-Conf-Control)#set ControlLoopRadioLocal off`
- 8 `GVFR(config-Conf-Control)#set InService on`

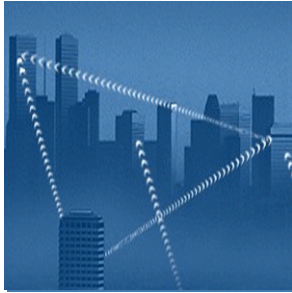

Appendix A

Specifications

This appendix provides technical specifications that support radio installation. These specifications support the guidance provided in the Site Survey. The example Transmission Power Specification chart is an example of the charts that come with each radio. These charts support power calculations and commissioning of each radio. Topics discussed in this appendix are as follows:

- “Mount specifications” on page 74
- “Raiser cabling specifications” on page 74
- “Example transmitter power specifications” on page 75

A.1 Mount specifications

The following are example specifications for possible mounting options (other suitable mounts may be used):

- Rooftop, non-penetrating mount: Baird
 - PSH-2: 4' Mast
 - Footprint: 32.0" x 46.8"
 - BPs-6, 8' Mast
 - Footprint: 10.75' x 10.75' to 16.1' x 16.1', as needed
 - Other mast heights available: special order
- Wall mount: Baird
WL-4. Concrete or wood wall material with optional wall offsets up to 60"
- Tower/pole mount:
 - Fixed vertical tower leg mount: Baird TM series.
 - Various types of mounts to accommodate round tower legs from 2–6" diameter, angle iron types, and compensating mounts for tower legs with angled, inward pitch.

A.2 Raiser cabling specifications

Verify cabling with the following connections are available at the installation site:

- Power: 48V DC power supply; low voltage; jacketed, 2-pair stranded wire:
 - Cable runs <200' use 18 gauge wire
 - Cable runs 200–300' use 16 gauge wire
 - Cable runs 300–400' use 14 gauge wire
- Fiber optic cable: Plenum jacketed as required by building code, rated at a minimum of 180 pound pull rating
 - Standard: 62.5 micron single-mode
 - Options (special order):
 - 62.5 Micron multi-mode
 - 50 Micron single mode
 - 50 Micron multi-mode
 - Connector types:
 - Standard: SC
 - Optional: LC
- Cat 5 or Cat 6 cable for network management, terminated with an RJ45
- Data/Radio Management:
Cat 5e jacket types:
 - PVC for non-plenum building installation
 - Plenum rated for building plenum required by building code

A.3 Example transmitter power specifications

Each radio is delivered with its own transmitter power specifications. The following are example tables for a 73GHz radio. Use the Transmitter Power Specification chart with the Power Calculator Tool to determine Dac A and Dac B power levels.

Example: If the rounded Pout Tx module is calculated to be 12 in the Power Calculator Tool, to determine Dac A and Dac B power levels, refer to the same value, 12, under the Power Level columns. Look across columns to determine the Tx values for Dac A and Dac B. In this example, for a power level of 12, Dac A should be set to 600 and Dac B should be set to 4059.

Table A-1 Transmitter Power Example

Dac A	Dac B	Power Detector	Power Level
4059	4059	1216	20
1155	4059	1062	19
1105	4059	916	18
1060	4059	760	17
1030	4059	666	16
975	4059	544	15
880	4059	436	14
820	4059	398	13
600	4059	336	12
600	1400	278	11
600	1240	236	10
600	1160	172	9
600	1140	148	8
600	1120	130	7
600	1095	104	6
600	1080	94	5
600	1050	82	4
600	1010	58	3
600	960	46	2
600	900	36	1
600	850	32	0

When peaking radios, refer to the lowest RSSI level to determine the highest signal strength. This is the value to align radios to when *peaking*.

Example: The lowest RSSI value is -30 and has a relative power indicator of 557 (next column). The value to align to is 557 when peaking radios (when observing the RSSI value while in the RSSI_graph mode on the laptop).

Table A-2 RSSI Example

(Received Signal Level)	(Relative Power Indicator)
-30	557
-35	563
-40	584
-45	625
-50	654
-55	688
-60	737
No Signal	>1200



Appendix B

CLI Quick Reference

This section provides a quick reference for top and sub-level Config commands in the CLI application. The following information is provided in this section:

- “CLI command tree table conventions” on page 78
- “CLI command tree” on page 78

B.1 CLI command tree table conventions

Tables describing CLI Config commands in this section use the following conventions to quickly guide you to specific information.

Common/Initial Setup functions
Sub-tree/General
SNMP/Trap Commands that should rarely be used

B.2 CLI command tree

The following tables are a quick reference of CLI commands. The Config command is a top level command after logging into the CLI. For basic CLI operation, refer to Chapter 4 “Operations” on page 31.

Table B-3 CONFIG Commands

CONFIG		
SFP		MAIN STATUS & CONFIGURATION
RAD		MAIN RADIO STATUS & CONFIGURATION
STAT		MAIN STATUS INFORMATION
CONF		MAIN CONFIGURATION
DIAG		MAIN DIAGNOSTICS CONTROL & STATUS

Table B-4 CONFIG / SFP / SFP1 Commands

CONFIG	SFP	SFP1	
		BASE	SFP1 Base configuration
		EXT	SFP1 Extendedbase configuration
		THRES	SFP1 Threshold constants
		CALIB	SFP1 Calibration constants
		AD	SFP1 Realtime readings
		STATUS	SFP1 Health status
		FLAG	SFP1 Flag status
		VENDMEM	SFP1 Vendormemory constants
		GBEAM	SFP1 Digital sense status
		TRAP	SFP1 Trap configuration

Table B-5 CONFIG / SFP / SFP1 / BASE Commands

CONFIG	SFP	SFP1	BASE			
			Id	get	SFP Serial Id	enum
			ExtId	get	SFP Extended Id	enum
			Connector	get	SFP Connector Type	enum
			Transceiver1	get	SFP Transceiver1 Codes	enum
			Transceiver2	get	SFP Transceiver2 Codes	enum
			Transceiver3	get	SFP Transceiver3 Codes	enum
			Transceiver4	get	SFP Transceiver4 Codes	enum
			Transceiver5	get	SFP Transceiver5 Codes	enum
			Transceiver6	get	SFP Transceiver6 Codes	enum
			Transceiver7	get	SFP Transceiver7 Codes	int
			Transceiver8	get	SFP Transceiver8 Codes	int
			Encoding	get	SFP Encoding Type	enum
			NomBR	get	SFP Nominal BR	int
			Length9ukm	get	SFP Length 9um in km	int
			Length9um	get	SFP Length 9um in 100m	int
			Length50um	get	SFP Length 50um	int
			Length62pt5um	get	SFP Length 62.5	int
			LengthCopper	get	SFP Length Copper	int
			VendorName	get	SFP Vendor Name	str
			VendorOUI	get	SFP Vendor OUI	oct
			VendorPN	get	SFP Vendor PN	str
			VendorRev	get	SFP Vendor Rev	str
			Wavelength	get	SFP Wavelength	int

Table B-6 CONFIG / SFP / SFP1 / EXT Commands

CONFIG	SFP	SFP1	EXT			
			Options	get	SFP Options	int
			BrMax	get	SFP BR Max	int
			BrMin	get	SFP BR Min	int
			VendorSN	get	SFP Vendor SN	str

Table B-6 CONFIG / SFP / SFP1 / EXT Commands (Continued)

CONFIG	SFP	SFP1	EXT			
			YearCode	get	SFP Year Date Code	str
			MonthCode	get	SFP Month Date Code	str
			DayCode	get	SFP Day Date Code	str
			LotCode	get	SFP Lot Code	str
			DiagType	get	SFP Diagnostics Type	int
			EnhancedOptions	get	SFP Enhanced Options	int
			Sff8472Compliance	get	SFP SFF-8472 Compliance	enum

Table B-7 CONFIG / SFP / SFP1 / THRES Commands

CONFIG	SFP	SFP1	THRES			
			TempHiAl	get/ set	Measured Temperature (Scaled in C)	int
			TempLoAl	get	Temp Low Alarm in C (Scaled in C)	int
			TempHiWa	get	Temp Hi Warning in C (Scaled in C)	int
			TempLoWa	get	Temp Low Warning in C (Scaled in C)	int
			VccHiAl	get	Voltage Hi Alarm in mVolts	int
			VccLoAl	get	Voltage Low Alarm in mVolts	int
			VccHiWa	get	Voltage Hi Warning in mVolts	int
			VccLoWa	get	Voltage Low Warning in mVolts	int
			TxBiasHiAl	get	Bias Hi Alarm in mA	int
			TxBiasLoAl	get	Bias Low Alarm in mA	int
			TxBiasHiWa	get	Bias Hi Warning in mA	int
			TxBiasLoWa	get	Bias Low Warning in mA	int
			TxPowerHiAl	get	Tx Power Hi Alarm in uW	int
			TxPowerLoAl	get	Tx Power Low Alarm in uW	int
			TxPowerHiWa	get	Tx Power Hi Warning in uW	int
			TxPowerLoWa	get	Tx Power Low Warning in uW	int
			RxPowerHiAl	get	Rx Power Hi Alarm in uW	int
			RxPowerLoAl	get	Rx Power Low Alarm in uW	int
			RxPowerHiWa	get	Rx Power Hi Warning in uW	int
			RxPowerLoWa	get	Rx Power Low Warning in uW	int

Table B-8 CONFIG / SFP / SFP1 / CALIB Commands

CONFIG	SFP	SFP1	CALIB			
			RxPwr4	get	Single precision FpTRx optical power	int
			RxPwr3	get	Single precision FpTRx optical power	int
			RxPwr2	get	Single precision FpTRx optical power	int
			RxPwr1	get	Single precision FpTRx optical power	int
			RxPwr0	get	Single precision FpTRx optical power	int
			TxISlope	get	Fixed decimal (unsigned) laser bias current	int
			TxIOffset	get	Fixed decimal(2's comp) laser bias current	int
			TxPwrSlope	get	Fixed decimal (unsigned) TX output power	int
			TxPwrOffset	get	Fixed decimal (2's comp) TX output power	int
			TSlope	get	Fixed decimal internal module temperature	int
			TOffset	get	Fixed decimal internal module temperature	int
			VSlope	get	Fixed decimal internal module supply voltage	int
			VOffset	get	Fixed decimal internal module supply voltage	int

Table B-9 CONFIG / SFP / SFP1 / AD Commands

CONFIG	SFP	SFP1	AD			
			Temp	get	Measured Temperature (Scaled in C)	int
			Vcc	get	Measured Voltage in mV	int
			TxBias	get	Measured TxBias Current in mA	int
			TxPower	get	Measured Tx Output Power in uW	int
			RxPower	get	Measured Rx Output Power in uW	int
			SignalErr	get	Signal Alarm Status for SFP1	enum

Table B-10 CONFIG / SFP / SFP1 / STATUS Commands

CONFIG	SFP	SFP1	STATUS			
			TxDisableState	get	State of Tx Disable Input Pin	enum
			RxRateSelectState	get	State of Rx Rate Select Input Pin	enum
			SoftRxRateSelect	get	Software Rx Rate Select	enum
			TxFault	get	State of Tx Fault Output Pin	enum
			Los	get	State of LOS Output Pin	enum
			DataReadyBar	get	Transceiver power and data ready	enum
			SignalErr	get	Signal Alarm Status for SFP1	enum
			SoftRxRateSelect	set	SoftwareRx Rate Select	enum

Table B-11 CONFIG / SFP / SFP1 / FLAG Commands

CONFIG	SFP	SFP1	FLAG			
			TempHiAl	get	Temperature over Hi Alarm Threshold	enum
			TempLoA	get	Temperature under Lo Alarm Threshold	enum
			VccHiA	get	Voltage over Hi Alarm Threshold	enum
			VccLoAl	get	Voltage under Lo Alarm Threshold	enum
			TxBiasHiAl	get	Tx Bias Current over Hi Alarm Threshold	enum
			TxBiasLoAl	get	Tx Bias Current under Lo Alarm Threshold	enum
			TxPowerHiAl	get	Tx Power over Hi Alarm Threshold	enum
			TxPowerLoAl	get	Tx Power under Lo Alarm Threshold	enum
			RxPowerHiAl	get	Rx Power over Hi Alarm Threshold	enum
			RxPowerLoAl	get	Rx Power under Lo Alarm Threshold	enum
			TempHiWa	get	Temperature over Hi Warning Threshold	enum
			TempLoWa	get	Temperature under Lo Warning Threshold	enum
			VccHiWa	get	Voltage over Hi Warning Threshold	enum
			VccLoWa	get	Voltage under Lo Warning Threshold	enum
			TxBiasHiWa	get	Tx Bias Current over Hi Warning Threshold	enum

Table B-11 CONFIG / SFP / SFP1 / FLAG Commands (Continued)

CONFIG	SFP	SFP1	FLAG			
			TxBiasLoWa	get	Tx Bias Current under Lo Warning Threshold	enum
			TxPowerHiWa	get	Tx Power over Hi Warning Threshold	enum
			TxPowerLoWa	get	Tx Power under Lo Warning Threshold	enum
			RxPowerHiWa	get	Rx Power over Hi Warning Threshold	enum
			RxPowerLoWa	get	Rx Power under Lo Warning Threshold	enum
			SignalErr	get	Signal Alarm Flag for SFP1	enum

Table B-12 CONFIG / SFP / SFP1 / VENDMEM Commands

CONFIG	SFP	SFP1	VENDMEM			
			VendorSpec	get	Vendor Specific	str

Table B-13 CONFIG / SFP / SFP1 / GBEAM Commands

CONFIG	SFP	SFP1	GBEAM			
			DsLolr	get	RX Optical Loss of Lock. Indication of CDR	enum
			DsLol	get	TX Optical Loss of Lock	enum

Table B-14 CONFIG / SFP / SFP1 / TRAP Commands

CONFIG	SFP	SFP1	TRAP			
			TempHiAlTrEnable	get/ set	E/D TRAP Temp over Hi Alarm Threshold	enum
			TempLoAlTrEnable	get/ set	E/D Trap for Temp under Lo Alarm Threshold	enum
			VccHiAlTrEnable	get/ set	E/D TRAP Volt over Hi Alarm Threshold	enum
			VccLoAlTrEnable	get/ set	E/D TRAP Volt under Lo Alarm Threshold	enum
			TxBiasHiAlTrEnable	get/ set	E/D TRAP Current over Hi Alarm Threshold	enum
			TxBiasLoAlTrEnable	get/ set	E/D TRAP Current under Lo Alarm Threshold	enum
			TxPowerHiAlTrEnable	get/ set	E/D TRAP TxPower over Hi Alarm Threshold	enum

Table B-14 CONFIG/ SFP / SFP1 / TRAP Commands (Continued)

CONFIG	SFP	SFP1	TRAP			
			TxPowerLoAlTrEnable	get/ set	E/D TRAP TxPower under Lo Alarm Threshold	enum
			RxPowerHiAlTrEnable	get/ set	E/D TRAP RxPower over Hi Alarm Threshold	enum
			RxPowerLoAlTrEnable	get/ set	E/D TRAP RxPower under Lo Alarm Threshold	enum
			TempHiWaTrEnable	get/ set	E/D TRAP Temp over Hi Warning Threshold	enum
			TempLoWaTrEnable	get/ set	Trap for Temp under Lo Warning Threshold	enum
			VccHiWaTrEnable	get/ set	E/D TRAP Volt over Hi Warning Threshold	enum
			VccLoWaTrEnable	get/ set	E/D TRAP Volt under Lo Warning Threshold	enum
			TxBiasHiWaTrEnable	get/ set	E/D TRAP Current over Hi Warning Threshold	enum
			TxBiasLoWaTrEnable	get/ set	E/D TRAP Current under Lo Warning Threshold	enum
			TxPowerHiWaTrEnable	get/ set	E/D TRAP Tx Power over Hi Warning Threshold	enum
			TxPowerLoWaTrEnable	get/ set	E/D TRAP Tx Power under Lo Warning Threshold	enum
			RxPowerHiWaTrEnable	get/ set	E/D TRAP Rx Power over Hi Warning Threshold	enum
			RxPowerLoWaTrEnable	get/ set	E/D TRAP Rx Power under Lo Warning Threshold	enum
			SignalErrTrEnable	get/ set	E/D TRAP1Signal Alarm Status	enum

Table B-15 CONFIG / RAD Commands

CONFIG	RAD	
	Base	RADIO BASE CONFIGURATION
	Ext	RADIO EXTENDED BASE CONFIGURATION
	Thres	RADIO THRESHOLD CONFIGURATION
	Diag	RADIO REALTIME READINGS
	Status	RADIO LOCAL & REMOTE STATUS
	Control	RADIO CONTROL CONFIGURATION
	Flag	RADIO FLAG STATUS

Table B-15 CONFIG / RAD Commands (Continued)

CONFIG		RAD
	Ad	RADIO ANALOG INTERFACE CONFIGURATION
	Ds	RADIO DIGITAL SENSE STATUS
	Trap	RADIO TRAP CONFIGURATION

Table B-16 CONFIG / RAD/ BASE Commands

CONFIG		RAD	BASE			
			CenterFreq	get	Current Radio Center Frequency	enum
			AntennaPol	get	Radio Antenna Polarization	enum
			AntennaType	get	Radio Antenna Type	enum
			Transceiver	get	Radio Channel Compatibility	enum
			Encoding	get	Radio Channel Coding	enum
			BitRate	get	Radio Bit Rate	int
			ChLength	get	Length supported by Channel	int
			VendorName	get	Radio Vendor Name	str
			VendorOUI	get	Radio Vendor OUI	str
			VendorPN	get	Radio Vendor PN	str
			VendorRev	get	Radio Vendor Rev	str

Table B-17 CONFIG/ RAD / EXT Commands

CONFIG		RAD	EXT			
			Options	get	Radio Diagnostic Options	int
			VendorSN	get	Radio Vendor SN	str
			YearCode	get	Radio Year Date Code	str
			MonthCode	get	Radio Month Date Code	str
			DayCode	get	Radio Day Date Code	str
			LotCode	get	Radio Lot Code	str
			DiagType	get	Radio Diagnostics Type	int
			DiagControl	get	Radio Diagnostics Control	int

Table B-18 CONFIG / RAD / THRES Commands

CONFIG	RAD	THRES				
			TempHiAl	get/ set	RAD Temp Hi Alarm Threshold in Deg Celsius	int
			TempLoAl	get/ set	RAD Temp Low Alarm Threshold in Deg Celsius	int
			TempHiWa	get/ set	RAD Temp Hi Warning Threshold in Deg Celsius	int
			TempLoWa	get/ set	RAD Temp Low Warning Threshold in Deg Celsius	int

Table B-19 CONFIG / RAD / DIAG Commands

CONFIG	RAD	DIAG				
			Temp	get	Temp in Degrees Celsius	int
			TxPower	get	Tx Power Reading in mW	int
			RxPower	get	Rx Power Reading in mW	int
			VDACREF	get	VDACREF Reading in mV	int

Table B-20 CONFIG / RAD / STATUS Commands

CONFIG	RAD	STATUS				
			LocalBER	log	Local Bit Error Rate	str
			RemoteBER	log	Bit Error Rate	str
			FrameSync	log	Radio Frame Sync	enum
			RemoteCommLinkStatus	log	Remote Radio Comm Link Status	enum
			LocalFER	log	Local Frame Error Rate	str
			RemoteFER	log	Remote Frame Error Rate	str
			RxDataPathAlarm	log	RX DataPath Alarm	enum
			TxDataPathAlarm	log	TX DataPath Alarm	enum
			RadioSignalAlarm	log	Radio Signal Fault Flag	enum
			CustomerSignalAlarm	log	CustomerSignal Fault Flag	enum
			LocalBER	get	Local Bit Error Rate	str
			RemoteBER	get	Bit Error Rate	str

Table B-20 CONFIG / RAD / STATUS Commands (Continued)

CONFIG	RAD	STATUS				
			FrameSync	get	Radio Frame Sync	enum
			RemoteCommLinkStatus	get	Remote Radio Comm Link Status	enum
			LocalFER	get	Local Frame Error Rate	str
			RemoteFER	get	Remote Frame Error Rate	str
			RxDataPathAlarm	get	RX DataPath Alarm	enum
			TxDataPathAlarm	get	TX DataPath Alarm	enum
			RadioSignalAlarm	get	Radio Signal Fault Flag	enum
			CustomerSignalAlarm	get	CustomerSignal Fault Flag	enum

Table B-21 CONFIG / RAD / CONTROL Commands

CONFIG	RAD	CONTROL				
			AutoPilot	get/ set	Enable or Disable AutoPilot feature	enum
			CostasLockDelay1	get/ set	Radio Control CostasLockDelay1 in microsec	int
			CostasLockDelay2	get/ set	Radio Control CostasLockDelay2 in microsec	int
			CostasLockDelay3	get/ set	Radio Control CostasLockDelay3 in microsec	int
			IQLIM	get/ set	LVAI-LVAQ diff threshold for Costas loop lock	int
			DcRadioShutdown	get/ set	Turn off radio power	enum
			DcRadioWarmdown	get/ set	Put radio in low power state	enum
			TxAESKeyEnable	get/ set	Enable TX AES Key	enum
			TxAESKey0	get/ set	16BIT TX AES Key 1	int
			TxAESKey1	get/ set	16BIT TX AES Key 2	int
			TxAESKey2	get/ set	16BIT TX AES Key 3	int
			TxAESKey3	get/ set	16BIT TX AES Key 4	int

Table B-21 CONFIG / RAD / CONTROL Commands (Continued)

CONFIG	RAD	CONTROL			
			TxAESKey4	get/ set	16BIT TX AES Key 5 int
			TxAESKey5	get/ set	16BIT TX AES Key 6 int
			TxAESKey6	get/ set	16BIT TX AES Key 7 int
			TxAESKey7	get/ set	16BIT TX AES Key 8 int
			TxAESKeyUpdate	get/ set	Update TX AES Key enum
			RxAESKeyEnable	get/ set	Enable RX AES Key enum
			RxAESKey0	get/ set	16BIT RX AES Key 1 int
			RxAESKey1	get/ set	16BIT RX AES Key 2 int
			RxAESKey2	get/ set	16BIT RX AES Key 3 int
			RxAESKey3	get/ set	16BIT RX AES Key 4 int
			RxAESKey4	get/ set	16BIT RX AES Key 5 int
			RxAESKey5	get/ set	16BIT RX AES Key 6 int
			RxAESKey6	get/ set	16BIT RX AES Key 7 int
			RxAESKey7	get/ set	16BIT RX AES Key 8 int
			RxAESKeyUpdate	get/ set	Update RX AES Key enum
			FECEnable	get/ set	FPGA FEC Enable enum
			cOut1	get	Last user set value of B1 bit of LMX2354 IFN int
			cOut0	get	Last user set value of B0 bit of LMX2354 IFN int
			NNUMB	get	Radio Control NNUMB parameter int
			LowBandSynthCmd	get	Radio Control LowBandSynthCmd parameter int
			HiBandSynthCmd	get	Radio Control HiBandSynthCmd parameter int

Table B-21 CONFIG / RAD / CONTROL Commands (Continued)

CONFIG	RAD	CONTROL			
			synth_config		Synthesizer Configuration Custom Command
			demod_config		Demodulator Configuration Custom Command

Table B-22 CONFIG / RAD / FLAG Commands

CONFIG	RAD	FLAG				
			TempHiAl	get	RADTemp Hi Alarm	enum
			TempLoAl	get	RADTemp Low Alarm	enum
			TempHiWa	get	RADTemp Hi Warning	enum
			TempLoWa	get	RADTemp Low Warning	enum
			CostasLock	get	Costas Lock Alarm Flag	enum
			DsSynthOk	get	Ext. Synth Fault Flag	enum
			CostasLoopLock	get	Costas Loop Lock Alarm Flag	enum
			TxDatapath	get	Tx Data Path Alarm Flag	enum
			RxDatapath	get	Rx Data Path Alarm Flag	enum
			RadioSignal	get	RadioSignal Alarm Flag	enum
			CustomerSignal	get	CustomerSignal Alarm Flag	enum
			DsRadioPresence	get	Radio Presence Alarm Flag	enum

Table B-23 CONFIG / RAD / AD Commands

CONFIG	RAD	AD				
			AsRssi	log	Analog RSSI in mV	int
			AcAgc	log	Automatic Gain ControlVoltage in nV	int
			AcTxBiasDACA	log	Tx Bias DAC A Setting	int
			AcTxBiasDACB	log	Tx Bias DAC B Setting	int
			AsTxBiasADC	log	Tx Bias ADC Setting	int
			AsTxTemp	log	Radio Temp Sensor in degrees C	int
			AsCostasLval	log	COSTAS LVA I	int
			AsCostasLvaQ	log	COSTAS LVA Q	int

Table B-23 CONFIG / RAD / AD Commands (Continued)

CONFIG	RAD	AD				
			AsCostasTune	log	COSTAS Tuning Voltage	int
			AsRssi	get	Analog RSSI in mV	int
			AcAgc	get	Automatic Gain ControlVoltage in mV	int
			AcTxBiasDACA	get	Tx Bias DAC A Setting	int
			AcTxBiasDACB	get	Tx Bias DAC B Setting	int
			AsTxBiasADC	get	Tx Bias ADC Setting	int
			AsTxTemp	get	Radio Temp Sensor in degrees C	int
			AsCostasLval	get	COSTAS LVA I	int
			AsCostasLvaQ	get	COSTAS LVA Q	int
			AsCostasTune	get	COSTAS Tuning Voltage	int
			AcAgc	set	Automatic Gain ControlVoltage in mV	int
			AcTxBiasDACA	set	Tx Bias DAC A Setting	int
			AcTxBiasDACB	set	Tx Bias DAC B Setting	int
			RSSI_graph		RSSI alignment graph	

Table B-24 CONFIG / RAD / DS Commands

CONFIG	RAD	DS				
			DsSynthOK	get	General Synth Status	enum
			DsCostasLock	get	Training Synthesizer Lock Status	enum
			DsRadioPresence	get	Radio Mod. & Demodulator Board Presence	enum
			DsCostasLoopLock	get	Costas PLL Lock Status	enum

Table B-25 CONFIG / RAD / TRAP Commands

CONFIG	RAD	TRAP				
			TempHiAlTrEnable	get/ set	E/D TRAP Temp over Hi Alarm Threshold	enum
			TempLoAlTrEnable	get/ set	Trap for Temperature under Lo Alarm Threshold	enum
			TempHiWaTrEnable	get/ set	E/D TRAP Temperature over Hi Warning Threshold	enum

Table B-25 CONFIG / RAD / TRAP Commands (Continued)

CONFIG	RAD	TRAP				
			TempLoWaTrEnable	get/ set	Trap for Temperature under Lo Warning Threshold	enum

Table B-26 CONFIG / STAT Commands

CONFIG	STAT	
	Rev	SOFTWARE & HARDWARE REVISION
	PSM	POWER SUPPLY MODULE ALARM STATUS
	Alarm	SUMMARY ALARM STATUS & TRAP CONFIGURATION
	Sfp	SFP STATUS

Table B-27 CONFIG / STAT / REV Commands

CONFIG	STAT	REV				
			SwBootRev	get	Rev of Bootloader code	str
			SwCurrentAppRev	get	Rev of Current App code	str
			SwBackupAppRev	get	Rev of Backup App code	str
			FPGARev	get	Rev of FPGA Code	oct
			HwCurrentBoardRev	get	Rev of Current Board	int
			ConfigRev	get	XML Database Configuration Revision	str

Table B-28 CONFIG / STAT / PSM Commands

CONFIG	STAT	PSM				
			PSMFuse1Alarm	get	PSM Fuse1 Alarm Status	enum
			PSMFuse2Alarm	get	PSM Fuse2 Alarm Status	enum
			PSMConverter1Alarm	get	PSM Conv1 Alarm	enum
			PSMConverter2Alarm	get	PSM Conv2 Alarm	enum

Table B-29 CONFIG / STAT / ALARM Commands

CONFIG	STAT	ALARM				
			SummaryAlarm	get	Card Summary Alarm Status/Bitmap	int
			SummaryAlarmTrEnable	get/ set	En/Dis TRAP Summary Alarm	enum
			GroupAlarmSfp1	get	Group Summary Alarm Status for1	int
			GroupAlarmSfp1TrEnable	get/ set	En/Dis TRAP Group Alarm1	enum
			GroupAlarmRad1	get	Group Summary Alarm Status for RADIO1	int
			GroupAlarmRad1TrEnable	get/ set	En/Dis TRAP Group Alarm RADIO1	enum
			GroupAlarmRad2	get	Group Summary Alarm Status for RADIO2	int
			GroupAlarmRad2TrEnable	get/ set	En/Dis TRAP Group Alarm RADIO2	enum
			GroupAlarmRad3	get	Group Summary Alarm Status for RADIO3	int
			GroupAlarmRad3TrEnable	get/ set	En/Dis TRAP Group Alarm RADIO3	enum
			GroupAlarmMisc	get	Group Summary Alarm Status for Miscellaneous	int
			GroupAlarmMiscTrEnable	get/ set	En/Dis TRAP Group Miscellaneous	enum
			alarm_dump		System alarm summary	

Table B-30 CONFIG / STAT / SFP Commands

CONFIG	STAT	SFP				
			Sfp1Status	get	SFP1 Status	enum
			SfpInterfaceType	get	Interface Type	enum

Table B-31 CONFIG / CONF Commands

CONFIG	CONF		
		Control	OPERATION CONTROL
		Async	AUTHENTICATION CONTROL & CONFIGURATION

Table B-31 CONFIG / CONF Commands (Continued)

CONFIG	CONF		
		Tftp	FIRMWARE TFTP CONFIGURATION
		Snmp	SNMP COMMSTRING & TRAP CONFIGURATION
		Ethernet	ETHERNET CONFIGURATION
		Misc	MISCELLANEOUS CONFIGURATION
		Control	OPERATION CONTROL
		Async	AUTHENTICATION CONTROL & CONFIGURATION

Table B-32 CONFIG / CONF / CONTROL Commands

CONFIG	CONF	CONTROL				
			InService	get/ set	SET In Service. Use only during loopback testing.	enum
			ControlLoopRadio	get/ set	SET Radio Loop mode	enum
			ControlLoopSFP1	get/ set	SET1 Loop mode	enum
			DebugLoop	get/ set	SET Debug Loop mode	int
			ControlLoopRadioLocal	get/ set	SET Radio Local Loop mode	enum

Table B-33 CONFIG / CONF / ASYNC Commands

CONFIG	CONF	ASYNC				
			Adminpwd	set	Admin User Password for Craft Port	pwd
			Ruserpwd	set	Restr User Password for Craft Port	pwd
			RadiusEnable	get/ set	Enable Radius Authentication	enum
			RadiusIP	get/ set	Radius Server IP Address for Async Port	IP
			RadiusSharedSecret	get/ set	Radius Shared Secret	int
			InactivityTimeout	get/ set	CLI inactivity timer period in seconds	int

Table B-33 CONFIG / CONF / ASYNC Commands (Continued)

CONFIG	CONF	ASYNC			
			reboot		Reboot Firmware[ARG:1-saved;2-factory]
			show flash		Show flash of the WiFiber unit
			download		Dnld Firmware[ARG:1-Init;2-Commit]
			setdatetime		Set DateTime as MM:DD:YYYY:HH:MM:ZZZ
			getdatetime		Get DateTime, as WW MM DD HH:MM:SS ZZZ YYYY
			viewlog		View Log of Files[ARG:1-SET;2-DEBUG]
			database		Init Database[ARG:1-Factory;2-Custom;3-Saved]

Table B-34 CONFIG / CONF / TFTP Commands

CONFIG	CONF	TFTP			
			Server	get/ set	TFTP Server IP Address IP
			Directory	get/ set	TFTP Server Directory str
			Filename	get/ set	Filename on TFTP Server str
			Download	get/ set	TFTP Server Download Command enum

Table B-35 CONFIG / CONF / SNMP

CONFIG	CONF	SNMP			
			TrapIP1	get/ set	SNMP TRAP IP Address 1 IP
			TrapIP2	get/ set	SNMP TRAP IP Address 2 IP
			SwitchSNMPMode	set	Switch/Toggle SNMP Mode from User and Install enum
			ReadCommString	get/ set	Read SNMP Community String str
			ReadWriteCommString	get/ set	Read-Write SNMP Community String str

Table B-35 CONFIG / CONF / SNMP (Continued)

CONFIG CONF SNMP						
			InstallCommString	get/ set	Install ONLY Read-Write SNMP Community String	str
			Trap1CommString	get/ set	Trap1 SNMP Community String	str
			Trap2CommString	get/ set	Trap2 SNMP Community String	str

Table B-36 CONFIG / CONF / ETHERNET Commands

CONFIG CONF ETHERNET						
			IPAddress	get/ set	IP Address	IP
			AddressMask	get/ set	IP Address Mask	IP
			Gateway	get/ set	IP Gateway	IP
			Reconfig	get/ set	IP Reconfig Command	enum
			MACAddress	get	MAC Address of Ethernet Port	str

Table B-37 CONFIG / CONF / MISC Commands

CONFIG CONF MISC						
			Save	get/ set	Save Current Runtime Configuration to Flash	enum
			TrapResendTimer	get/ set	Trap Resent Timer (in minutes)	int

Table B-38 CONFIG / DIAG Commands

CONFIG DIAG						
			SelfTestConfig	get/ set	Self Test Start/Stop	enum
			SelfTestStatus	get	Self Test Status	enum

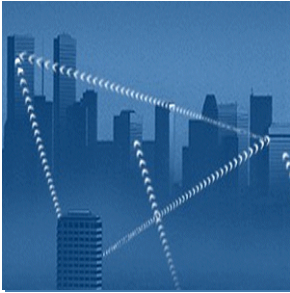

Appendix C

Mechanical Drawings and Pinouts

This appendix provides technical illustration of radio components, cables, and pinouts. Illustrations included in this section are as follows:

- “Radio Assembly Description (rear view)” on page 98
- “LC/SC 9/125 SM Fiber Cable Assembly” on page 101
- “LC/SC 62.5/125 MM Fiber Cable Assembly” on page 102
- “LC/SC 50/125 MM Fiber Cable Assembly” on page 103
- “10BaseT, CAT5 Cable Assembly” on page 104
- “External Power CPC to 1/4” Ring Lug” on page 105
- “Power Cable Pinouts” on page 106

C.1 Radio Assembly Description (rear view)

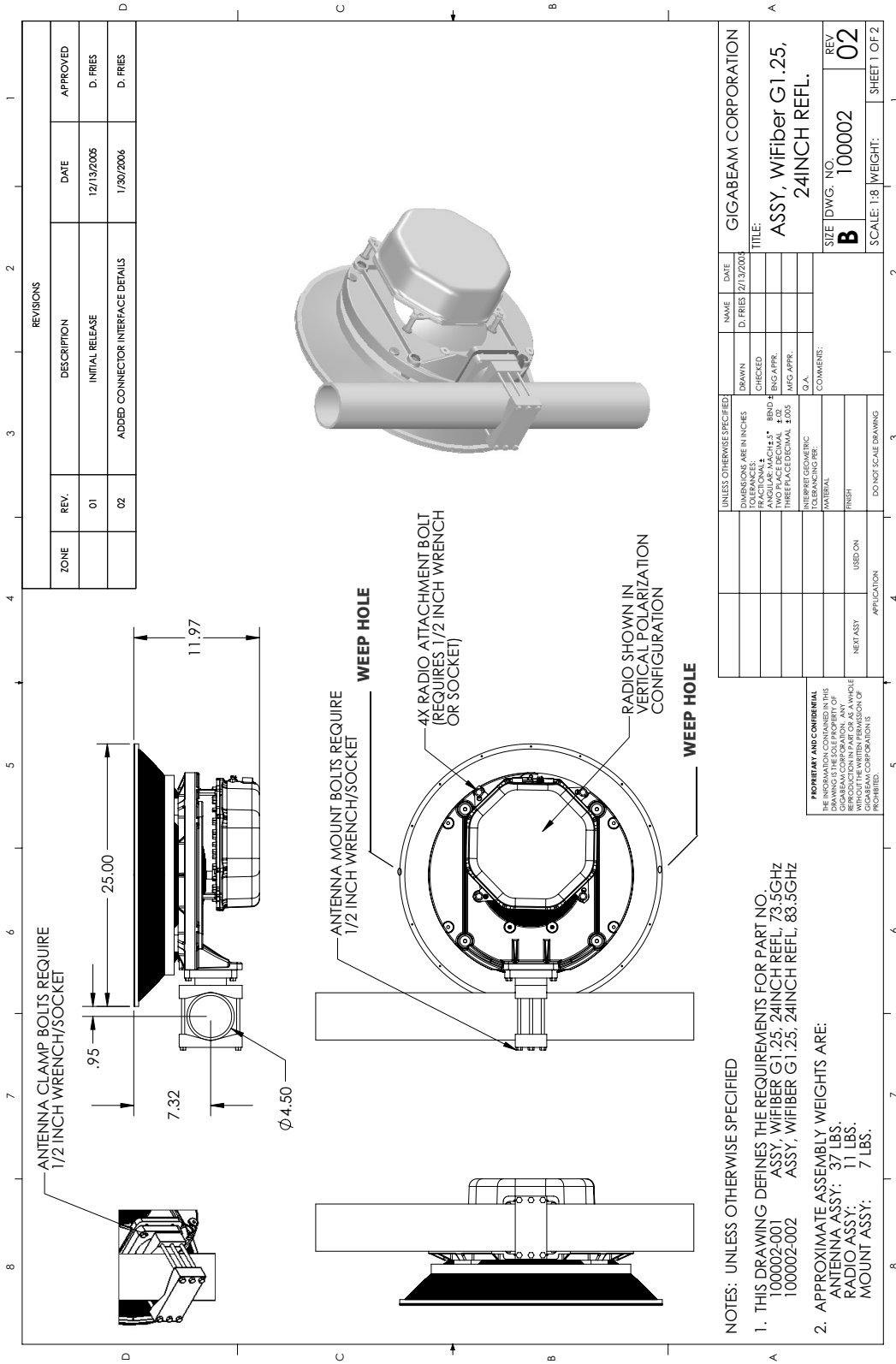

C.2 Radio Assembly Description (rear view 2)

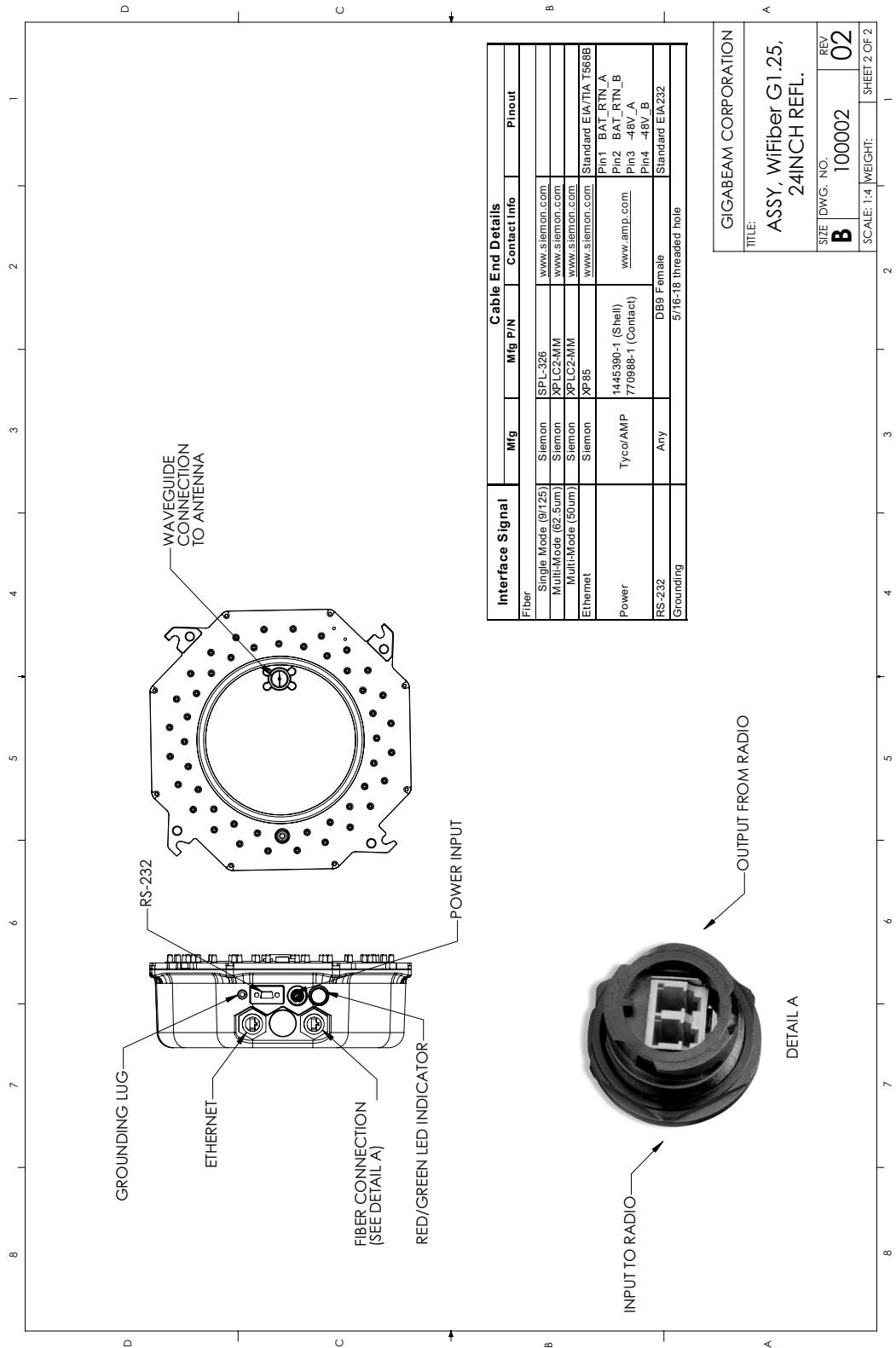

C.3 Radio Assembly Description (rear view 3)

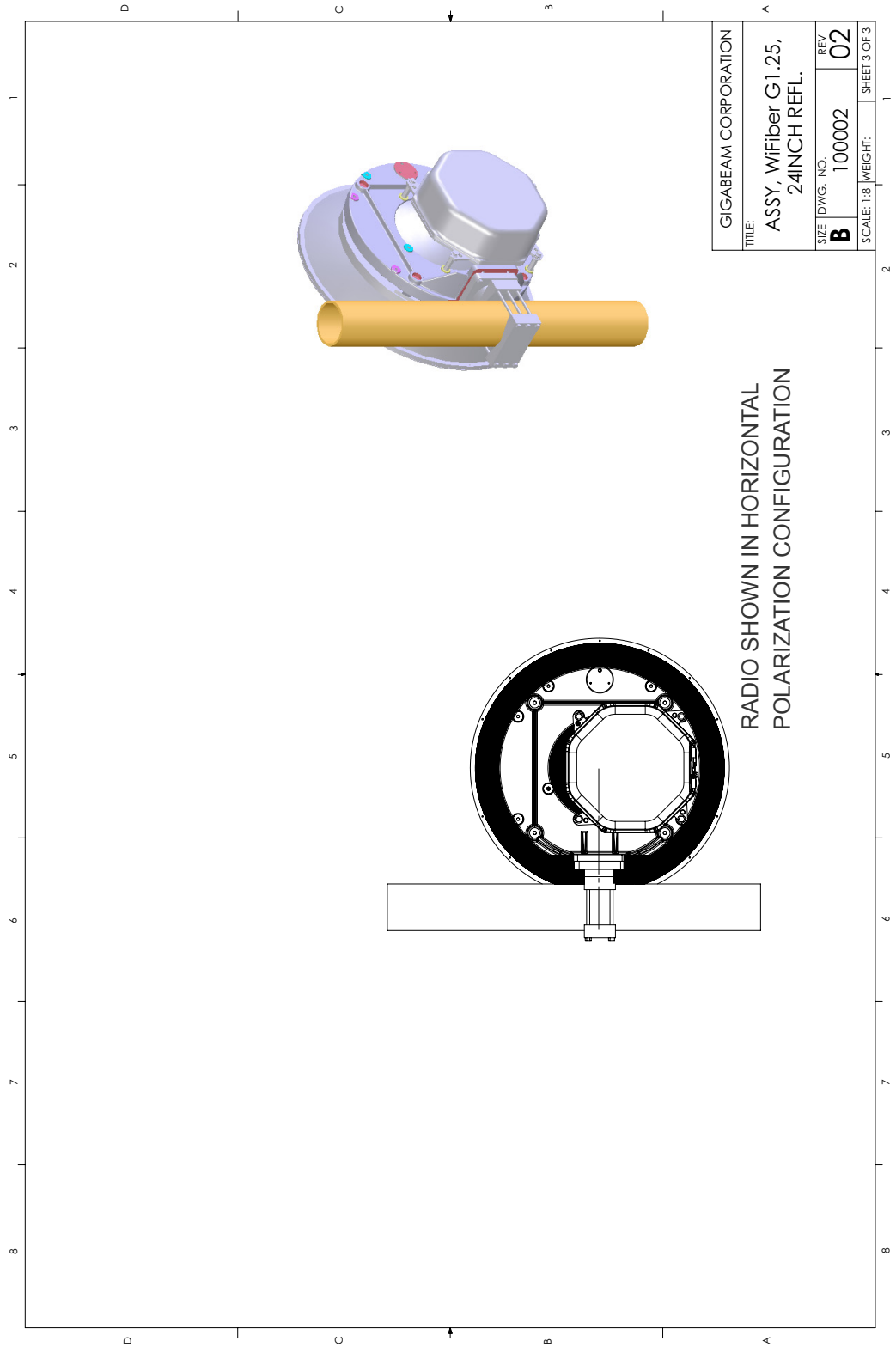

C.4 LC/SC 9/125 SM Fiber Cable Assembly

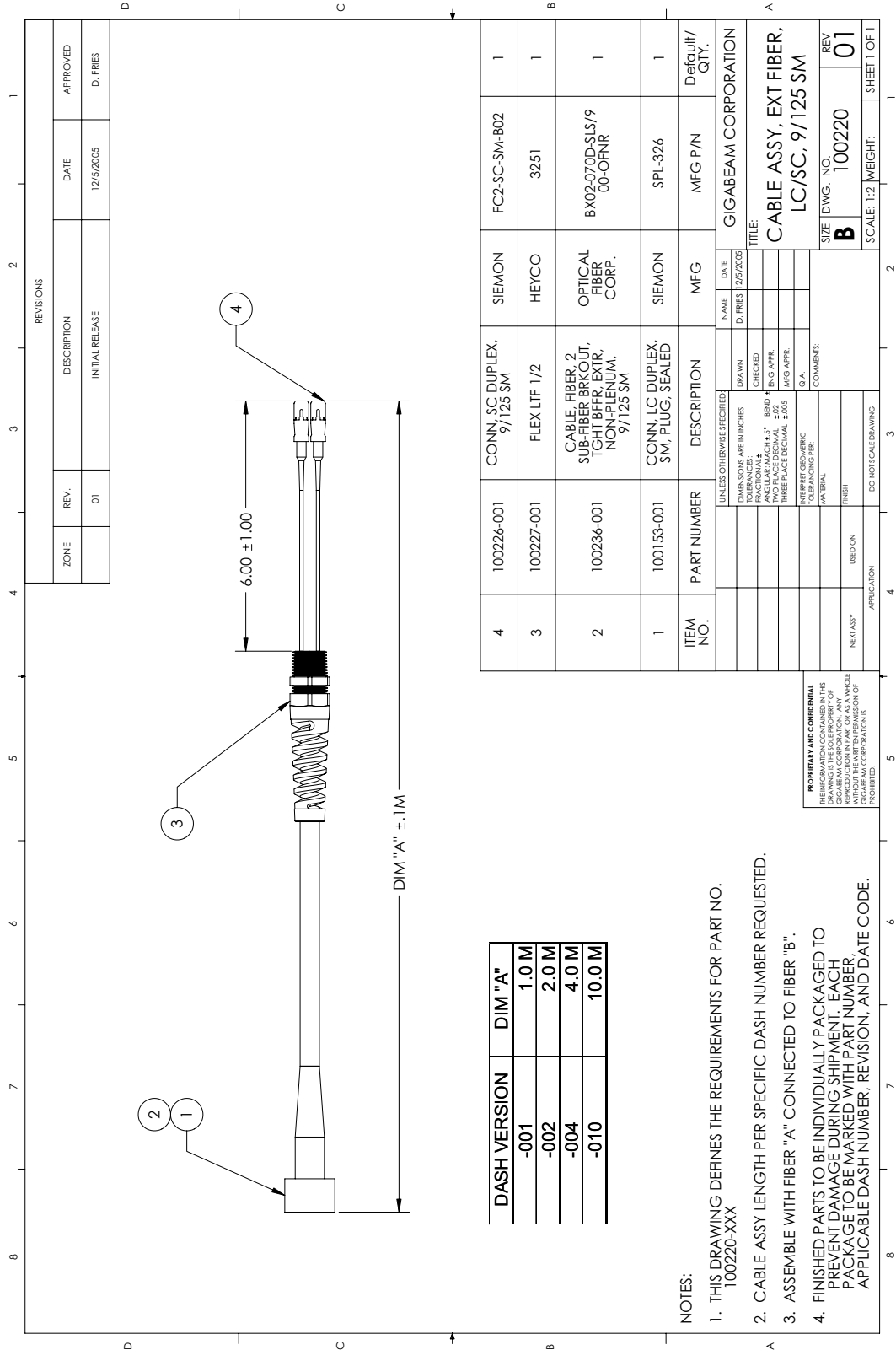

C.5 LC/SC 62.5/125 MM Fiber Cable Assembly

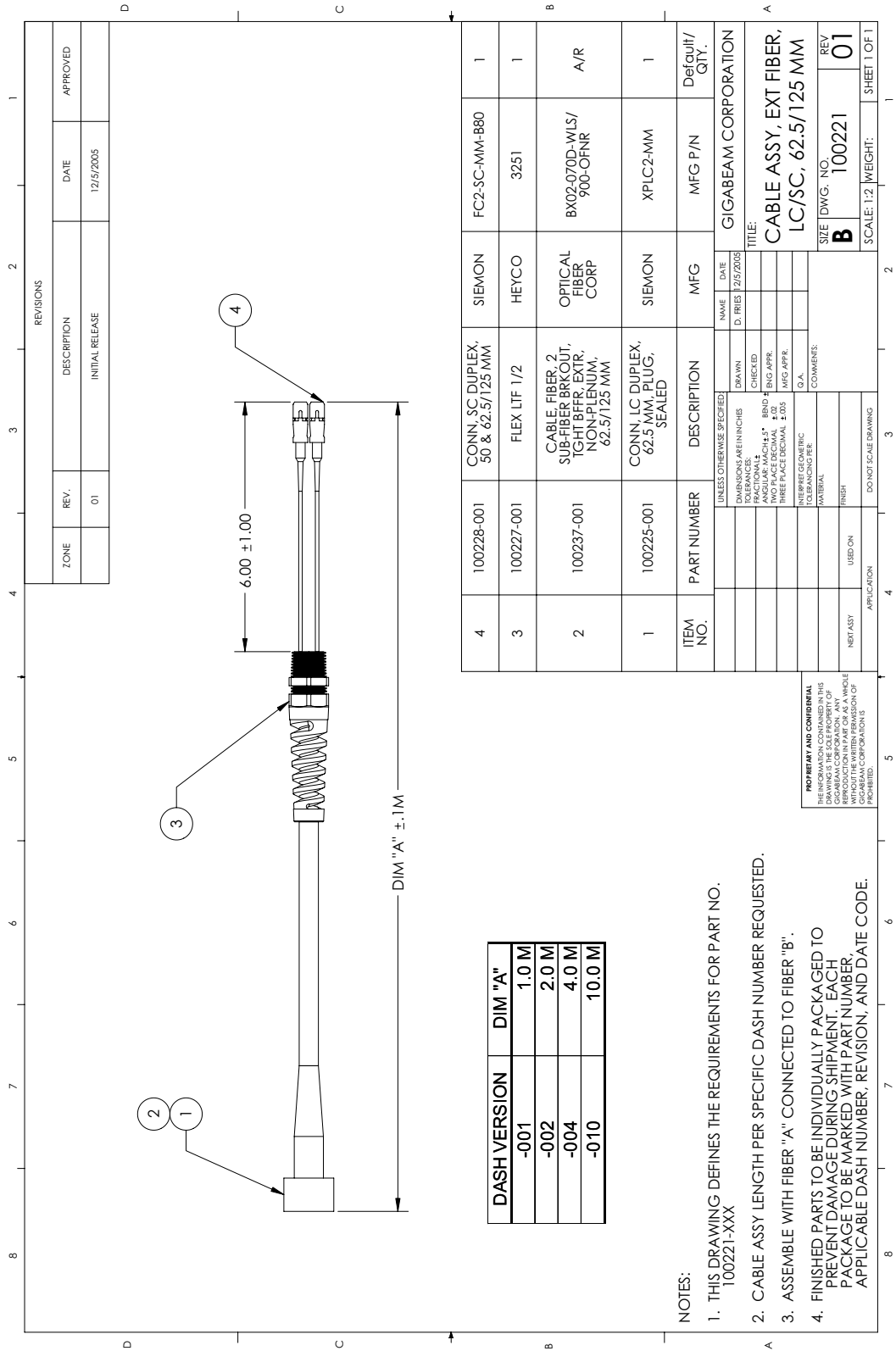

C.6 LC/SC 50/125 MM Fiber Cable Assembly

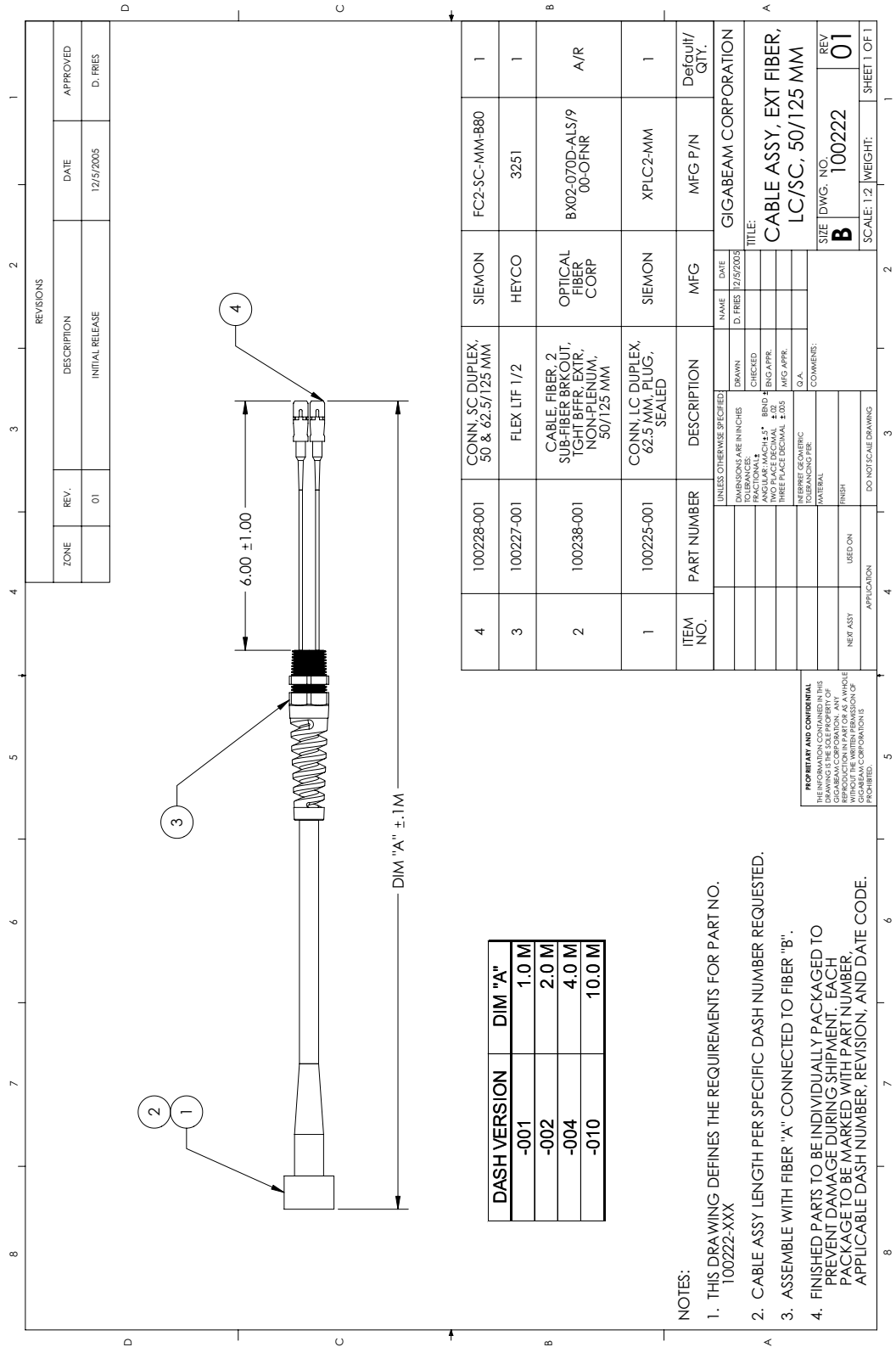

C.7 10BaseT, CAT5 Cable Assembly

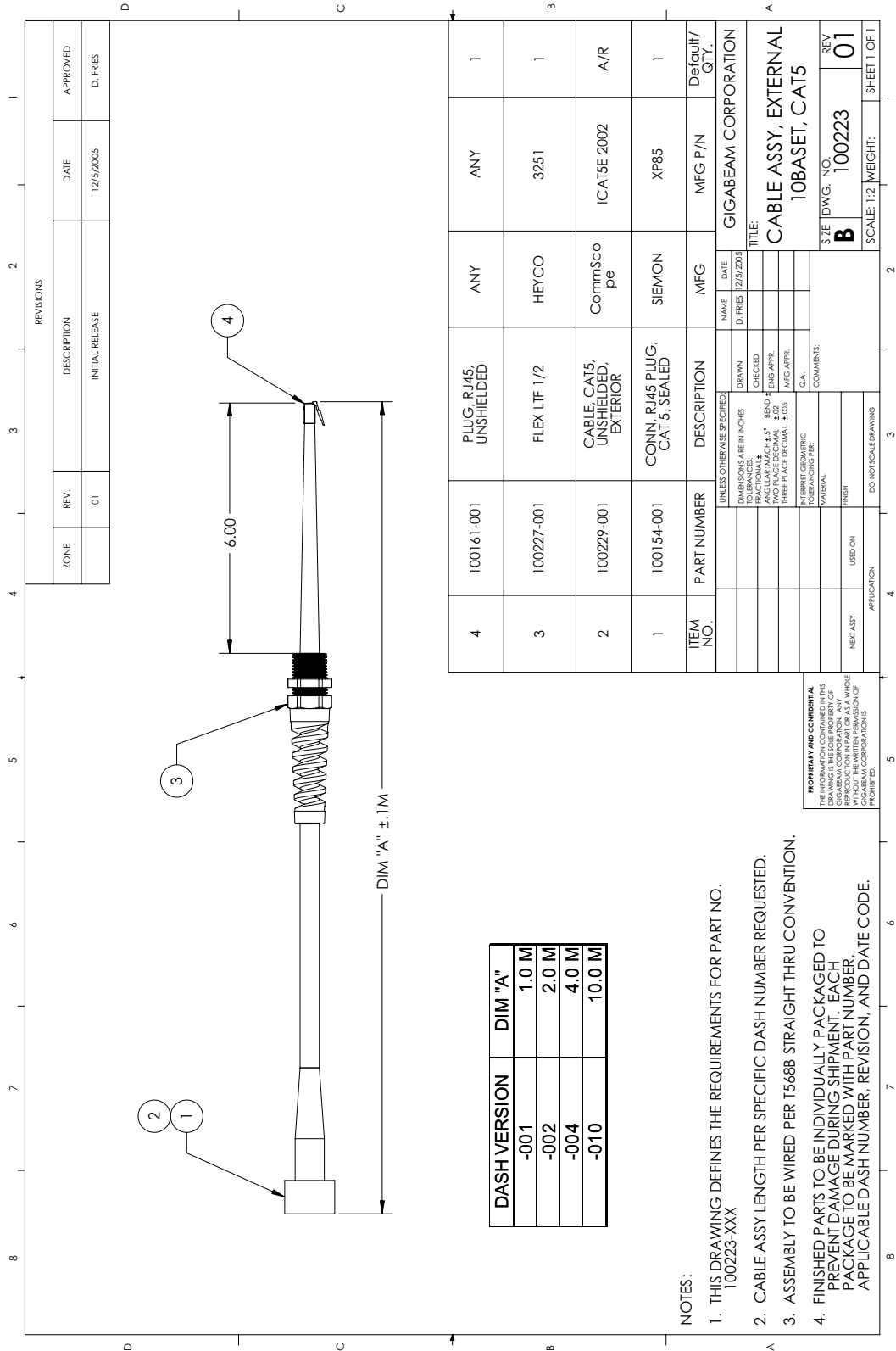

C.8 External Power CPC to 1/4" Ring Lug

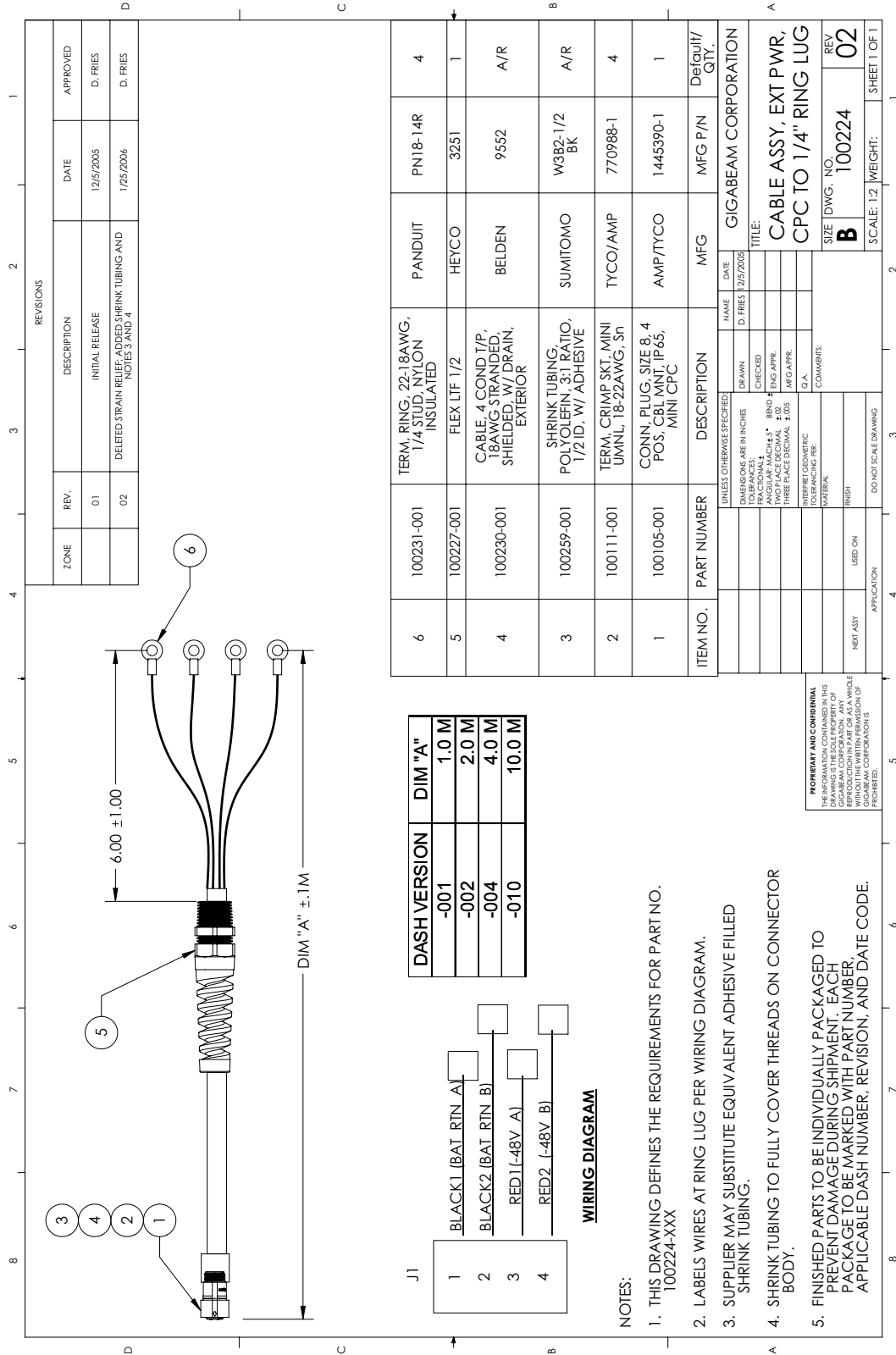

C.9 Power Cable Pinouts

The following table describes the color-coded power cable pinouts which coordinate with the molded pin numbers on the connector.

Table C-39 Mini CPC Power Cable Connector Pinouts

Pin Number	Color	Description
1	Black 1	Battery return A
2	Black2	Battery return B
3	Red1	-48V A
4	Red2	-48V B

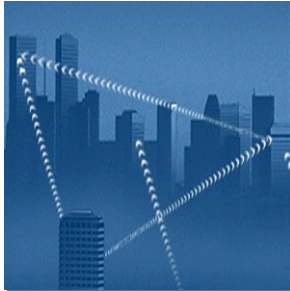

Appendix D

MIB Tree and Alarm Structures

This appendix describes the MIB tree structure and the Summary and Group alarm object structures and bitmap values in the Routing Controller Module (RCM). Topics discussed in this appendix are as follows:

- “About the MIB tree structure” on page 108
- “About RCM alarm structures” on page 110
 - “SummaryAlarm object” on page 111
 - “SummaryAlarm object” on page 111
 - “GroupAlarmSfp1 object” on page 112
 - “GroupAlarmMisc object” on page 115
 - “GroupAlarmRad1 object” on page 117
 - “GroupAlarmRad3 object” on page 117

D.1 About the MIB tree structure

The following table describes all parts of the tree structure. For individual object descriptions, load the MIB file into the MIB browser and refer to the individual objects.

Table D-40 MIB Tree Structure Objects and Description

Object	Description
GbeamSfp (.1.3.6.1.4.1.22113.1):	RCM SFP diagnostics and status.
Gbeamsfp1 (.1.3.6.1.4.1.22113.1.1):	RCM SFP diagnostics and status for SFP 1.
GbeamSfp1Base (.1.3.6.1.4.1.22113.1.1.1):	RCM SFP Base ID fields as per SFF-8472 (Digital Diagnostic Monitoring Interface for Optical Transceivers).
GbeamSfp1Ext (.1.3.6.1.4.1.22113.1.1.2):	RCM SFP Extended ID fields as per SFF-8472 (Digital Diagnostic Monitoring Interface for Optical Transceivers).
GbeamSfp1Threshold (.1.3.6.1.4.1.22113.1.1.3):	RCM SFP manufacturer specified alarm thresholds for Temperature, Vcc, TxBias, TxPower and RxPower SFP attributes.
GbeamSfp1Calib (.1.3.6.1.4.1.22113.1.1.4):	RCM SFP manufacturer specified calibration constants.
GbeamSfp1Ad (.1.3.6.1.4.1.22113.1.1.5):	RCM SFP internal A/D values.
GbeamSfp1Status (.1.3.6.1.4.1.22113.1.1.6):	RCM SFP status bitfield values.
GbeamSfp1Flag (.1.3.6.1.4.1.22113.1.1.7):	RCM SFP alarm flag values. Tells you what alarms are currently present on the SFP.
GbeamSfp1Vendormem (.1.3.6.1.4.1.22113.1.1.8):	RCM SFP vendor-specific objects.
GbeamSfp1Gbeam (.1.3.6.1.4.1.22113.1.1.9):	RCM SFP GigaBeam specific objects.
GbeamSfp1Trap (.1.3.6.1.4.1.22113.1.1.10):	RCM SFP Trap enable configuration objects.
GbeamRad (.1.3.6.1.4.1.22113.2):	RCM Radio Hardware diagnostics and status.
GbeamRadBase (.1.3.6.1.4.1.22113.2.1):	RCM Radio Base ID fields such as CenterFreq and AntennaType.
GbeamRadExt (.1.3.6.1.4.1.22113.2.2):	RCM Radio Extended ID fields such as YearCode and LotCode.
GbeamRadThreshold (.1.3.6.1.4.1.22113.2.3):	RCM Radio Alarm and Warning thresholds under user-control.
GbeamRadDiag (.1.3.6.1.4.1.22113.2.4):	RCM Radio Diagnostic elements such as DAC reference and system temperature.
GbeamRadStatus (.1.3.6.1.4.1.22113.2.5):	RCM Radio Status elements such as BER and FER as well as the state of various onboard alarms.

Table D-40 MIB Tree Structure Objects and Description (Continued)

Object	Description
GbeamRadControl (.1.3.6.1.4.1.22113.2.6):	RCM Radio control of Costas Locking Algorithm parameters such as IQLIM and also the command strings for programming the external synthesizer to low or to high frequency. Contains the values for the AES Encryption keys.
GbeamRadFlag (.1.3.6.1.4.1.22113.2.7):	RCM Radio alarm flags. These flags tell you the state of various radio alarm conditions on the RCM.
GbeamRadAd (.1.3.6.1.4.1.22113.2.8):	RCM Radio A to D converter objects such as Costas LVAI and LVAQ, RSSI and AGC.
GbeamRadDs (.1.3.6.1.4.1.22113.2.9):	RCM Radio Digital status objects such as DsSynthOK, DsCostasLoopLock, and DsCostasLock.
GbeamRadTrap (.1.3.6.1.4.1.22113.2.10):	RCM Radio Trap enable objects. These objects allow for the masking of radio specific traps.
GbeamStat (.1.3.6.1.4.1.22113.3):	RCM Radio Hardware diagnostics and status.
GbeamStatRev (.1.3.6.1.4.1.22113.3.1):	RCM Radio Hardware and Software Component Revisions. Here you will find the Software Version, FPGA Version and Bootloader Version.
GbeamStatPSM (.1.3.6.1.4.1.22113.3.2):	RCM Power Supply Alarm and Fault status.
GbeamStatAlarm (.1.3.6.1.4.1.22113.3.3):	RCM Summary Alarm, Group Alarm and Alarm enable objects.
GbeamStatSfp (.1.3.6.1.4.1.22113.3.4):	RCM SFP Status objects.
GbeamConf (.1.3.6.1.4.1.22113.4):	RCM System configuration tree.
GbeamConfControl (.1.3.6.1.4.1.22113.4.1):	Control of loopback facilities on the RCM Platform.
GbeamConfAsync (.1.3.6.1.4.1.22113.4.2):	Control of settings for user authentication via RADIUS.
GbeamConfTftp (.1.3.6.1.4.1.22113.4.3):	TFTP server settings for remote firmware upgrade.
GbeamConfSnmp (.1.3.6.1.4.1.22113.4.4):	Trap IP Address settings.
GbeamConfSnmp (.1.3.6.1.4.1.22113.4.5):	TFTP server settings for remote firmware upgrade.
GbeamConfMisc (.1.3.6.1.4.1.22113.4.6):	Saving of configuration object and also the trap resending intervals can be specified through the objects in this tree.
GbeamDiag (.1.3.6.1.4.1.22113.5):	RCM System Diagnostics tree. Not implemented.
GbeamInstall(.1.3.6.1.4.1.22113.10):	RCM Installation tree. This tree exists simply to integrate with the JAVA factory installation utility. That installation utility uses SNMP in order to configure various install time attributes such as the radio's center frequency and antenna type. In order to access this tree, you must first login to the CLI interface as admin. Then you need to set the conf-snmp-SwitchSNMPMode object to install. Now, in order to get the objects in the GbeamInstall tree, you will need to use the default read/write community string "install".
GbeamInstallBase(.1.3.6.1.4.1.22113.10.1):	Radio factory configuration settings such as Center Frequency, and Antenna type.

Table D-40 MIB Tree Structure Objects and Description (Continued)

Object	Description
GbeamInstallExt(.1.3.6.1.4.1.22113.10.2):	Radio factory configuration settings such as lot codes and date codes.
GbeamInstallMisc(.1.3.6.1.4.1.22113.10.3):	The save object located in this tree can be used to save the installation tree objects to flash.

D.2 About RCM alarm structures

There are numerous events that trigger alarms. These are called Individual Alarm Objects. Typically, they reside in either the Status or Flag trees underneath the main branches. The Individual Alarm Objects are organized into Group Alarms. Group Alarms are in turn organized into Summary Alarms. This structure makes it easier to see what is happening at the system level. For instance, we can trace backwards from the Summary Alarm and determine what individual part of the system is in alarm state. Group Alarms and Summary Alarms trigger traps. Various individual alarms send traps as well, but not all of them. The sending of a trap can be enabled/disabled by the corresponding enable object for each alarm.

Note:



Even if the trap is disabled, the corresponding bit of the Alarm will be set but the trap will not be sent.

Group and summary alarms are bit-maps in integer representation. This means that each bit of the alarm has a specific meaning. If this value is converted to binary representation, you can determine the meaning of the alarm using the following sections.

Note:



The traps generated by the RCM board are SNMPv2 traps.

Table D-41 Varbinds of the Enterprise Specific Traps

Varbind Position	Varbind Name	Description
1	SysUptime	MIB 2 element denoting the number of time ticks that this system has been running.
2	TrapOID	The Object Identifier (OID) of this trap. This varbind is needed to adhere to the structure of generic SNMPv2 traps.
3	Trap Varbind	This is the object that we bind to the trap. This object is specified in the tables below when we state "Varbind". Currently the RCM system only supports one Varbind per trap.

D.2.1 SummaryAlarm object

The SummaryAlarm object on the RCM system is comprised of five Group Alarms. If any of the individual alarms of the Group Alarms are set, then the corresponding Group Alarm bit in the Summary Alarm Object will be set. The following figure shows how the group alarms are organized into the SummaryAlarm Bitmap.

The SummaryAlarm and each GroupAlarm have an associated trap that is sent whenever there is a change of state in these alarm bits. Table D-42 describes each of these traps and how they can be enabled/disabled.

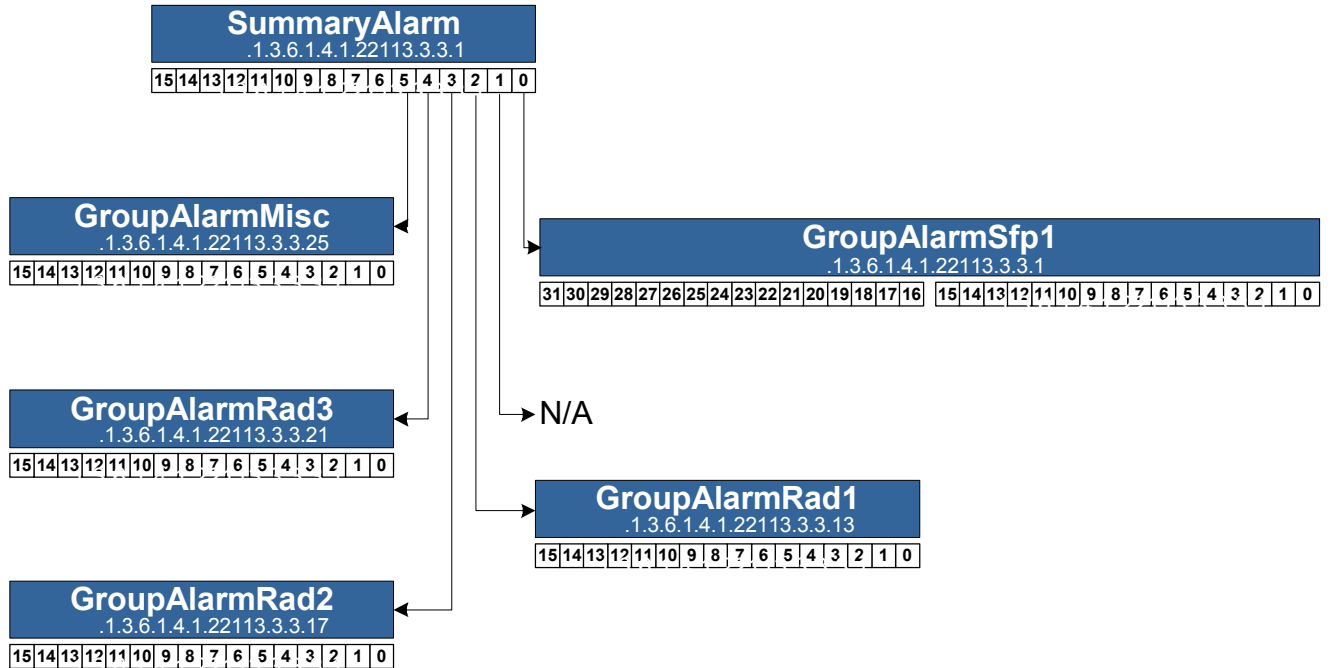

Figure D-1 The RCM SummaryAlarm Bitmap.

Table D-42 Summary Alarm and Group Alarm Traps

Alarm (OID)	Description	Trap Enable Object (OID)	Trap OID/Return to Normal Trap OID	Varbind (used for both Active and Cancel)
SummaryAlarm .1.3.6.1.4.1.22113.3.3.1	System Summary Alarm Object. This object gives a high level view of system health	SummaryAlarmTrEnable .1.3.6.1.4.1.22113.3.3.2	1.3.6.1.4.1.22113.3.3.3/ 1.3.6.1.4.1.22113.3.3.4	SummaryAlarm .1.3.6.1.4.1.22113.3.3.1
GroupAlarmSFP1 .1.3.6.1.4.1.22113.3.3.5	SFP Summary Alarm Object. This object gives various indications of SFP status	GroupAlarmSfp1TrEnable .1.3.6.1.4.1.22113.3.3.6	1.3.6.1.4.1.22113.3.3.7/ .1.3.6.1.4.1.22113.3.3.8	GroupAlarmSFP1 .1.3.6.1.4.1.22113.3.3.5
GroupAlarmMisc .1.3.6.1.4.1.22113.3.3.25	Misc. Alarms including SFP LOS, Costas Loop Loss of Lock and Power Supply Faults.	GroupAlarmMiscTrEnable .1.3.6.1.4.1.22113.3.3.26	1.3.6.1.4.1.22113.3.3.27/ 1.3.6.1.4.1.22113.3.3.28	GroupAlarmMisc .1.3.6.1.4.1.22113.3.3.25
GroupAlarmRad1 .1.3.6.1.4.1.22113.3.3.13	Radio System Temperature Alarms from the LM77 temperature sensor	GroupAlarmRad1TrEnable .1.3.6.1.4.1.22113.3.3.14	.1.3.6.1.4.1.22113.3.3.15/ .1.3.6.1.4.1.22113.3.3.16	GroupAlarmRad1 .1.3.6.1.4.1.22113.3.3.13
GroupAlarmRad2 .1.3.6.1.4.1.22113.3.3.17	N/A	N/A	N/A	
GroupAlarmRad3 .1.3.6.1.4.1.22113.3.3.21	DCC Link fault and also RadioSignal and CustomerSignal Alarms. Radio signal alarms occur when you have Radio LOS, loss of frame sync or FPGA Deframer FIFO errors. Customer Signal Alarms occur when you have FIFO errors on the Framer side of the FPGA.	GroupAlarmRad3TrEnable .1.3.6.1.4.1.22113.3.3.22	.1.3.6.1.4.1.22113.3.3.23/ .1.3.6.1.4.1.22113.3.3.24	GroupAlarmRad3 .1.3.6.1.4.1.22113.3.3.21

D.2.2 GroupAlarmSfp1 object

The GroupAlarmSfp1 object is a collection of individual alarms that pertain to the operation of the SFP. The following figure describes the bits of the GroupAlarmSfp1 alarm object. Each of the individual alarm objects that comprise the GroupAlarmSfp1 alarm can trigger traps. The configuration of these traps is described in [Table D-43](#).

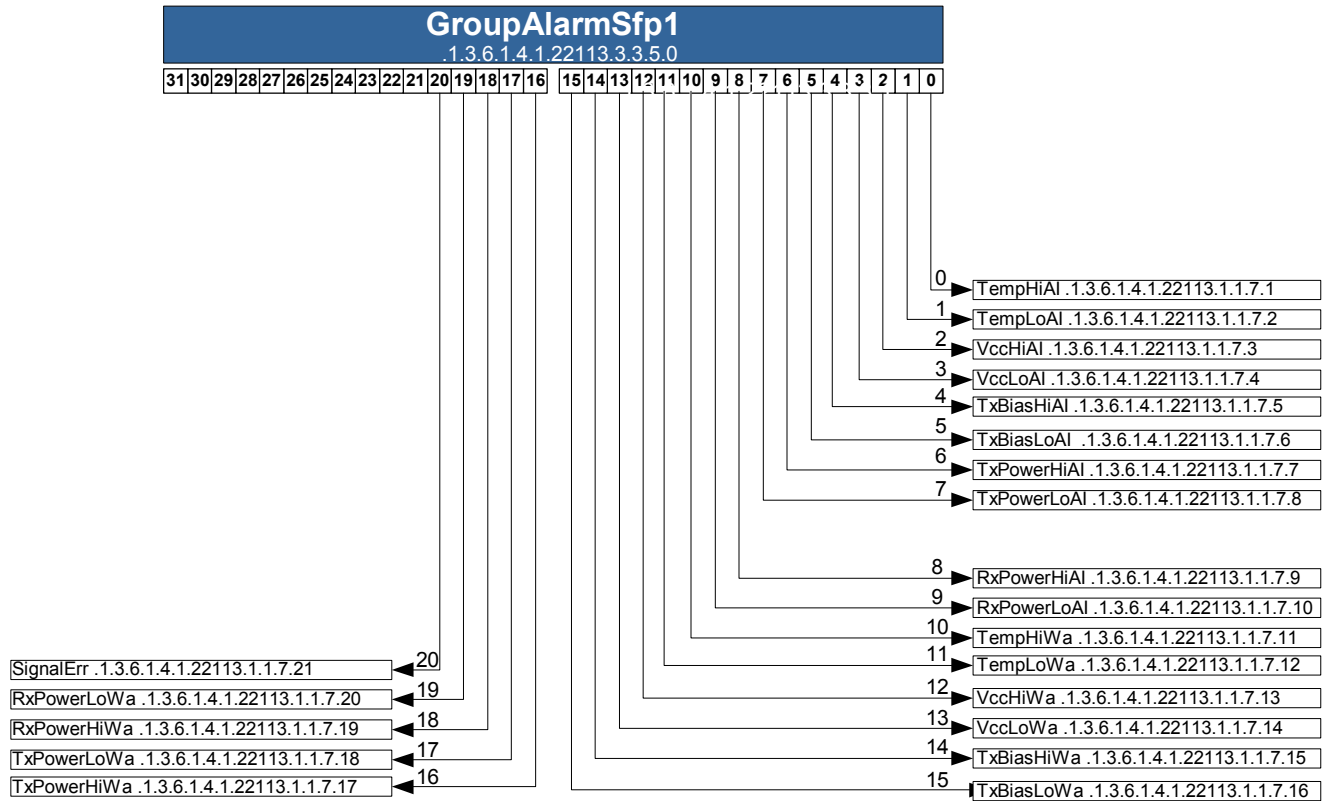

Figure D-2 The RCM GroupAlarmSfp1 bitmap.

Table D-43 GroupAlarmSfp1 Object Traps

Alarm (OID)	Description	Trap Enable Object (OID)	Trap OID/Return to Normal Trap OID	Varbind (used for both Active and Cancel)
TempHiAl .1.3.6.1.4.1.22113.1.1.7.1	Temp over Hi Alarm Threshold on SFP	TempHiAlTrEnable .1.3.6.1.4.1.22113.1.1.10.1	.1.3.6.1.4.1.22113.1.1.10.2/ .1.3.6.1.4.1.22113.1.1.10.3	Temp .1.3.6.1.4.1.22113.1.1.5.1
TempLoAl .1.3.6.1.4.1.22113.1.1.7.2	Temp over Lo Alarm Threshold on SFP	TempLoAlTrEnable .1.3.6.1.4.1.22113.1.1.10.4	.1.3.6.1.4.1.22113.1.1.10.5/ .1.3.6.1.4.1.22113.1.1.10.6	Temp .1.3.6.1.4.1.22113.1.1.5.1
VccHiAl .1.3.6.1.4.1.22113.1.1.7.3	Voltage over Hi Alarm Threshold on SFP	VccHiAlTrEnable .1.3.6.1.4.1.22113.1.1.10.7	.1.3.6.1.4.1.22113.1.1.10.7.1/ .1.3.6.1.4.1.22113.1.1.10.7.2	Vcc .1.3.6.1.4.1.22113.1.1.5.2
VccLoAl .1.3.6.1.4.1.22113.1.1.7.4	Voltage over Lo Alarm Threshold on SFP	VccLoAlTrEnable .1.3.6.1.4.1.22113.1.1.10.10	.1.3.6.1.4.1.22113.1.1.10.10.1/ .1.3.6.1.4.1.22113.1.1.10.10.2	Vcc .1.3.6.1.4.1.22113.1.1.5.2
TxBiasHiAl .1.3.6.1.4.1.22113.1.1.7.5	Tx Bias Current over Hi Alarm Threshold on SFP	TxBiasHiAlTrEnable .1.3.6.1.4.1.22113.1.1.10.13	.1.3.6.1.4.1.22113.1.1.10.14/ .1.3.6.1.4.1.22113.1.1.10.15	TxBias .1.3.6.1.4.1.22113.1.1.5.3
TxBiasLoAl .1.3.6.1.4.1.22113.1.1.7.6	Tx Bias Current under Lo Alarm Threshold on SFP	TxBiasLoAlTrEnable .1.3.6.1.4.1.22113.1.1.10.16	.1.3.6.1.4.1.22113.1.1.10.17/ .1.3.6.1.4.1.22113.1.1.10.18	TxBias .1.3.6.1.4.1.22113.1.1.5.3
TxPowerHiAl .1.3.6.1.4.1.22113.1.1.7.7	Tx Power over Hi Alarm Threshold on SFP	TxPowerHiAlTrEnable .1.3.6.1.4.1.22113.1.1.10.19	.1.3.6.1.4.1.22113.1.1.10.20/ .1.3.6.1.4.1.22113.1.1.10.21	TxPower .1.3.6.1.4.1.22113.1.1.5.4
TxPowerLoAl .1.3.6.1.4.1.22113.1.1.7.8	Tx Power under Lo Alarm Threshold on SFP	TxPowerLoAlTrEnable .1.3.6.1.4.1.22113.1.1.10.22	.1.3.6.1.4.1.22113.1.1.10.23/ .1.3.6.1.4.1.22113.1.1.10.24	TxPower .1.3.6.1.4.1.22113.1.1.5.4
RxPowerHiAl .1.3.6.1.4.1.22113.1.1.7.9	Rx Power over Hi Alarm Threshold on SFP	RxPowerHiAlTrEnable .1.3.6.1.4.1.22113.1.1.10.25	.1.3.6.1.4.1.22113.1.1.10.26/ .1.3.6.1.4.1.22113.1.1.10.27	RxPower .1.3.6.1.4.1.22113.1.1.5.5
RxPowerLoAl .1.3.6.1.4.1.22113.1.1.7.10	Rx Power under Lo Alarm Threshold on SFP	RxPowerLoAlTrEnable .1.3.6.1.4.1.22113.1.1.10.28	.1.3.6.1.4.1.22113.1.1.10.29/ .1.3.6.1.4.1.22113.1.1.10.30	RxPower .1.3.6.1.4.1.22113.1.1.5.5
TempHiWa .1.3.6.1.4.1.22113.1.1.7.11	Temp over Hi Warning Thresh. On SFP	TempHiWaTrEnable .1.3.6.1.4.1.22113.1.1.10.31	.1.3.6.1.4.1.22113.1.1.10.32/ .1.3.6.1.4.1.22113.1.1.10.33	Temp .1.3.6.1.4.1.22113.1.1.5.1
TempLoWa .1.3.6.1.4.1.22113.1.1.7.12	Temp. under Lo Warning Thresh. on SFP	TempLoWaTrEnable .1.3.6.1.4.1.22113.1.1.10.34	.1.3.6.1.4.1.22113.1.1.10.35/ .1.3.6.1.4.1.22113.1.1.10.36	Temp .1.3.6.1.4.1.22113.1.1.5.1
VccHiWa .1.3.6.1.4.1.22113.1.1.7.13	Voltage over Hi Warning Thresh. on SFP	VccHiWaTrEnable .1.3.6.1.4.1.22113.1.1.10.37	.1.3.6.1.4.1.22113.1.1.10.38/ .1.3.6.1.4.1.22113.1.1.10.39	Vcc .1.3.6.1.4.1.22113.1.1.5.2
VccLoWa .1.3.6.1.4.1.22113.1.1.7.14	Voltage under Lo Warning Thresh. on SFP	VccLoWaTrEnable .1.3.6.1.4.1.22113.1.1.10.40	.1.3.6.1.4.1.22113.1.1.10.41/ .1.3.6.1.4.1.22113.1.1.10.42	Vcc .1.3.6.1.4.1.22113.1.1.5.2

Table D-43 GroupAlarmSfp1 Object Traps (Continued)

Alarm (OID)	Description	Trap Enable Object (OID)	Trap OID/Return to Normal Trap OID	Varbind (used for both Active and Cancel)
TxBiasHiWa .1.3.6.1.4.1.22113.1.1.7.15	Tx Bias Current over Hi Warning Thresh. on SFP	TxBiasHiWaTrEnable .1.3.6.1.4.1.22113.1.1.10.43	.1.3.6.1.22113.1.1.10.44/ .1.3.6.1.22113.1.1.10.45	TxBias .1.3.6.1.4.1.22113.1.1.5.3
TxBiasLoWa .1.3.6.1.4.1.22113.1.1.7.16	Tx Bias Current under lo warning thresh. on SFP	TxBiasLoWaTrEnable .1.3.6.1.4.1.22113.1.1.10.46	.1.3.6.1.22113.1.1.10.47/ .1.3.6.1.22113.1.1.10.48	TxBias .1.3.6.1.4.1.22113.1.1.5.3
TxPowerHiWa .1.3.6.1.4.1.22113.1.1.7.17	Tx Power over Hi Warning Thresh. on SFP	TxPowerHiWaTrEnable .1.3.6.1.4.1.22113.1.1.10.49	.1.3.6.1.4.1.22113.1.1.10.50/ .1.3.6.1.4.1.22113.1.1.10.51	TxPower .1.3.6.1.4.1.22113.1.1.5.4
TxPowerLoWa .1.3.6.1.4.1.22113.1.1.7.18	Tx Power under lo warning thresh. on SFP	TxPowerLoWaTrEnable .1.3.6.1.4.1.22113.1.1.10.52	.1.3.6.1.4.1.22113.1.1.10.53/ .1.3.6.1.4.1.22113.1.1.10.54	TxPower .1.3.6.1.4.1.22113.1.1.5.4
RxPowerHiWa .1.3.6.1.4.1.22113.1.1.7.19	Rx Power over Hi warning thresh. on SFP	RxPowerHiWaTrEnable .1.3.6.1.4.1.22113.1.1.10.55	.1.3.6.1.4.1.22113.1.1.10.56/ .1.3.6.1.4.1.22113.1.1.10.57	RxPower .1.3.6.1.4.1.22113.1.1.5.5
RxPowerLoWa .1.3.6.1.4.1.22113.1.1.7.20	Rx Power under lo warning thresh. on SFP	RxPowerLoWaTrEnable .1.3.6.1.4.1.22113.1.1.10.58	.1.3.6.1.4.1.22113.1.1.10.59/ .1.3.6.1.4.1.22113.1.1.10.60	RxPower .1.3.6.1.4.1.22113.1.1.5.5
SignalErr .1.3.6.1.4.1.22113.1.1.7.21	Signal Alarm Flag for SFP. This is active when there is SFP LOS or SFP Tx Fault	SignalErrTrEnable .1.3.6.1.4.1.22113.1.1.10.61	.1.3.6.1.4.1.22113.1.1.10.62/ .1.3.6.1.4.1.22113.1.1.10.63	SignalErr .1.3.6.1.4.1.22113.1.1.5.6

D.2.3 GroupAlarmMisc object

The GroupAlarmMisc object is a group alarm object that includes various miscellaneous alarms. It contains the SFP loss of signal alarm from the SFP; it contains various Costas Loop hardware alarms including CostasLock and CostasLoopLock; it holds the synthesizer OK alarm and also various Power Supply alarms. The bit mapping of the GroupAlarmMisc object is shown in the following figure. A description of the objects to configure the various traps associated with the alarms is shown in [Table D-44](#).

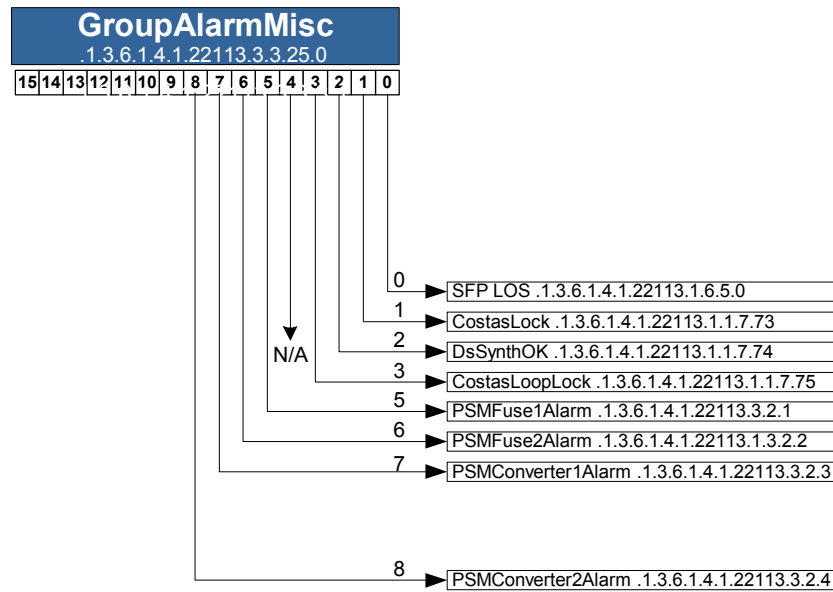

Figure D-3 RCM GroupAlarmMisc Bitmap.

Table D-44 GroupAlarmMisc Traps

Alarm (OID)	Description	Trap Enable Object (OID)	Trap OID/Return to Normal Trap OID	Varbind (used for both Active and Cancel)
LOS .1.3.6.1.4.1.22113.1.1.6.5.0	SFP Loss of Signal Alarm	SignalErrTrEnable .1.3.6.1.4.1.22113.1.1.10.61	.1.3.6.1.4.1.22113.1.1.10.62/ .1.3.6.1.4.1.22113.1.1.10.63	SignalErr .1.3.6.1.4.1.22113.1.1.5.5
CostasLock .1.3.6.1.4.1.22113.1.1.7.73	Costas Training Synthesizer Lock Status	N/A (Not individually Trap-able. Available only through GroupAlarmMisc Trap)	N/A (Not individually Trap-able. Available only through GroupAlarmMisc Trap)	
DsSynthOK .1.3.6.1.4.1.22113.1.1.7.74	External Synthesizer OK.	N/A (Not individually Trap-able. Available only through GroupAlarmMisc Trap)	N/A (Not individually Trap-able. Available only through GroupAlarmMisc Trap)	
CostasLoopLock .1.3.6.1.4.1.22113.1.1.7.75	State of the Costas Loop Lock as determined by the difference in the LVAI and LVAQ by software.	N/A (Not individually Trap-able. Available only through GroupAlarmMisc Trap)	N/A (Not individually Trap-able. Available only through GroupAlarmMisc Trap)	
PSMFuse1Alarm .1.3.6.1.4.1.22113.3.2.1	Power Supply Module Fuse 1 Alarm	N/A (Not individually Trap-able. Available only through GroupAlarmMisc Trap)	N/A (Not individually Trap-able. Available only through GroupAlarmMisc Trap)	
PSMFuse2Alarm .1.3.6.1.4.1.22113.3.2.2	Power Supply Module Fuse 2 Alarm	N/A (Not individually Trap-able. Available only through GroupAlarmMisc Trap)	N/A (Not individually Trap-able. Available only through GroupAlarmMisc Trap)	
PSMConverter1Alarm .1.3.6.1.4.1.22113.3.2.3	Power Supply Module Converter 1 Alarm	N/A (Not individually Trap-able. Available only through GroupAlarmMisc Trap)	N/A (Not individually Trap-able. Available only through GroupAlarmMisc Trap)	
PSMConverter2Alarm .1.3.6.1.4.1.22113.3.2.4	Power Supply Module Converter 2 Alarm	N/A (Not individually Trap-able. Available only through GroupAlarmMisc Trap)	N/A (Not individually Trap-able. Available only through GroupAlarmMisc Trap)	

D.2.4 GroupAlarmRad1 object

The GroupAlarmRad1 object shows temperature alarms from the radio system. These alarms are based on the readings from the National LM77 temperature sensor. The thresholds for these alarms are set in the GbeamRadThreshold tree. The bits where the individual alarms are mapped into the GroupAlarmRad1 are shown in the following figure. The traps that can be sent based on the Individual alarms in GroupAlarmRad1 are shown in Table D-45.

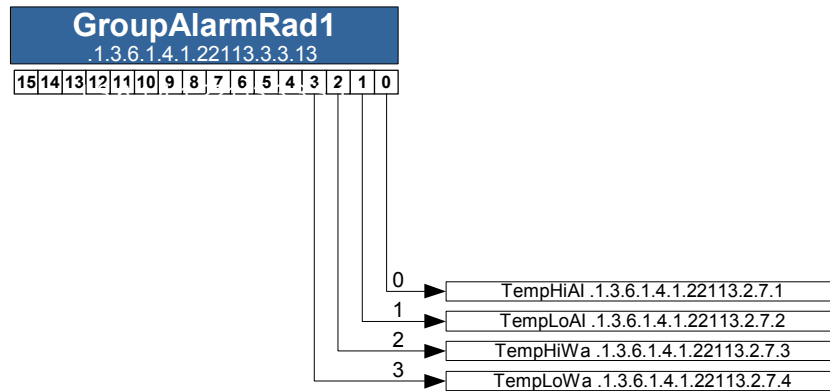

Figure D-4 The RCM GroupAlarmRad1 bitmap.

Table D-45 GroupAlarmRad1 Traps

Alarm (OID)	Description	Trap Enable Object (OID)	Trap OID/Return to Normal Trap OID	Varbind (used for both Active and Cancel)
TempHiAl .1.3.6.1.4.1.22113.2.7.1	Radio Temp above hi threshold alarm	TempHiAlTrEnable .1.3.6.1.4.1.22113.2.10.1	.1.3.6.1.4.1.22113.2.10.2/ .1.3.6.1.4.1.22113.2.10.3	Temp .1.3.6.1.4.1.22113.2.4.1
TempLoAl .1.3.6.1.4.1.22113.2.7.2	Radio Temp below low threshold alarm	TempLoAlTrEnable .1.3.6.1.4.1.22113.2.10.4	.1.3.6.1.4.1.22113.2.10.5/ .1.3.6.1.4.1.22113.2.10.6	Temp .1.3.6.1.4.1.22113.2.4.1
TempHiWa .1.3.6.1.4.1.22113.2.7.3	Radio Temp above Hi warning threshold alarm	TempHiWaTrEnable .1.3.6.1.4.1.22113.2.10.109	.1.3.6.1.4.1.22113.2.10.110/ .1.3.6.1.4.1.22113.2.10.111	Temp .1.3.6.1.4.1.22113.2.4.1
TempLoWa .1.3.6.1.4.1.22113.2.7.4	Radio Temp below low warning threshold alarm	TempHiWaTrEnable .1.3.6.1.4.1.22113.2.10.112	.1.3.6.1.4.1.22113.2.10.113/ .1.3.6.1.4.1.22113.2.10.114	Temp .1.3.6.1.4.1.22113.2.4.1

D.2.5 GroupAlarmRad3 object

The GroupAlarmRad3 object contains Individual alarms that pertain to the DCC link, the radio signal (for example, LOS and Loss of Frame Sync) and the Customer Signal (Customer LOS and Tx Fault conditions). The bits where the individual alarms are mapped into the GroupAlarmRad3 are shown in the following figure. The traps that can be sent based on the individual alarms in GroupAlarmRad3 are shown in Table D-46.

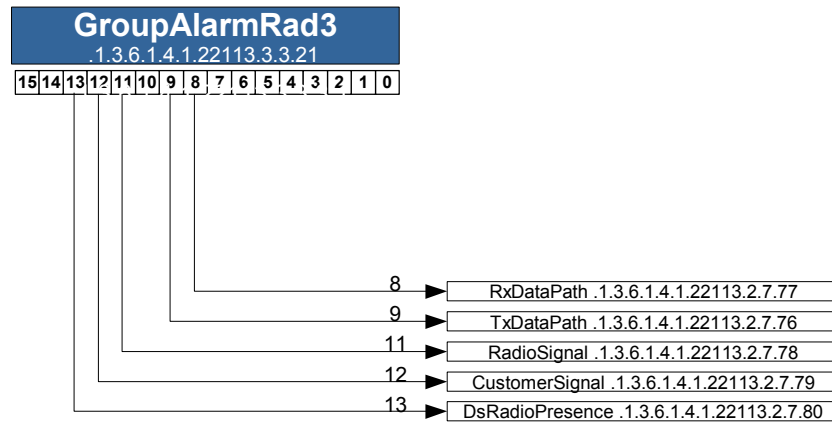

Figure D-5 The RCM GroupAlarmRad3 bitmap.

Table D-46 GroupAlarmRad3 Traps

Alarm (OID)	Description	Trap Enable Object (OID)	Trap OID/Return to Normal Trap OID	Varbind (used for both Active and Cancel)
RxDataPath .1.3.6.1.4.1.22113.2.7.77	RX Data Path alarm from the DCC Link	N/A (Not individually Trapable. Available only through GroupAlarmRad3 Trap)	N/A (Not individually Trapable. Available only through GroupAlarmRad3 Trap)	N/A
TxDataPath .1.3.6.1.4.1.22113.2.7.76	TX Data Path alarm from the DCC Link	N/A (Not individually Trapable. Available only through GroupAlarmRad3 Trap)	N/A (Not individually Trapable. Available only through GroupAlarmRad3 Trap)	N/A
RadioSignal .1.3.6.1.4.1.22113.2.7.78	Radio Signal Alarm. Set in the case of either Radio Loss of Signal, Radio Loss of Frame Sync or if the FIFO Full/Empty bits of the FPGA Deframer Status register are set.	N/A (Not individually Trapable. Available only through GroupAlarmRad3 Trap)	N/A (Not individually Trapable. Available only through GroupAlarmRad3 Trap)	N/A
CustomerSignal .1.3.6.1.4.1.22113.2.7.79	Customer Signal Alarm. Set in the case of FIFO Full or Empty error in the Framers of FPGA or in the case of Customer Loss of Signal.	N/A (Not individually Trapable. Available only through GroupAlarmRad3 Trap)	N/A (Not individually Trapable. Available only through GroupAlarmRad3 Trap)	N/A
DsRadioPresence .1.3.6.1.4.1.22113.2.7.80	Radio Presence Alarm. Should never be in Alarm state for the RCM.	N/A (Not individually Trapable. Available only through GroupAlarmRad3 Trap)	N/A (Not individually Trapable. Available only through GroupAlarmRad3 Trap)	N/A



Appendix E

WiFiber Installer Console

This appendix describes the WiFiber Installer Console application, its features, installation, and operation. Topics discussed in this section include the following:

- “About the WiFiber Installer Console” on page 120
- “Installing the WiFiber Installer Console application” on page 120
- “WiFiber Installer overview” on page 121
 - “Main tab” on page 122
 - “IP Settings tab” on page 124
 - “Alarm Settings tab” on page 125
 - “TxPower Calculation tab” on page 126
 - “WiFiber RSSI Alignment tab” on page 128

E.1 About the WiFiber Installer Console

The WiFiber Installer Console is an application that supports commissioning of radios. The application will run on a Windows XP operating system and requires hyperterminal communications, a DB9, female-to-female cable from the laptop to the radio serial port. You do not need an IP address when using this type of connection.

The WiFiber console provides real-time data that supports commissioning of radios and includes the following features:

- Visual indication of the RSSI along with the peak RSSI indication in large display format for alignment purposes.
- Visual display of Costas LVal and LVaQ values to indicate if the Costas Loop is locked
- Display of radio setup information including Center Frequency, WiFiber Serial Number and SFP LOS indication.
- Control of the Autopilot and InService variables.
- Displays an alarm summary screen that shows all current radio alarms, which are updated approximately once per second.
- Provides IP configuration ability.
- Calculates distance to Pout Tx Module power calculation, based on the center frequency of the radio and antenna type.

E.2 Installing the WiFiber Installer Console application

To install the application, proceed as follows:

- 1 Save the `dist.zip` file to a folder on the laptop hard drive.
- 2 Extract the `dist.zip` file using Winzip.
- 3 Double-click the `main.exe` file to launch the WiFiber Installer Console.
The Main screen displays. The fields on the main screen will be blank until the application is configured for the radio.

E.3 Configuring console for radio

After launching the WiFiber Installer Console, the Main screen displays. To display real-time radio data, the Installer must be configured for the radio.

- 1 Click **File > Connect to WiFiber**.

The following dialog displays. Serial Port COM1 is the default serial port.:

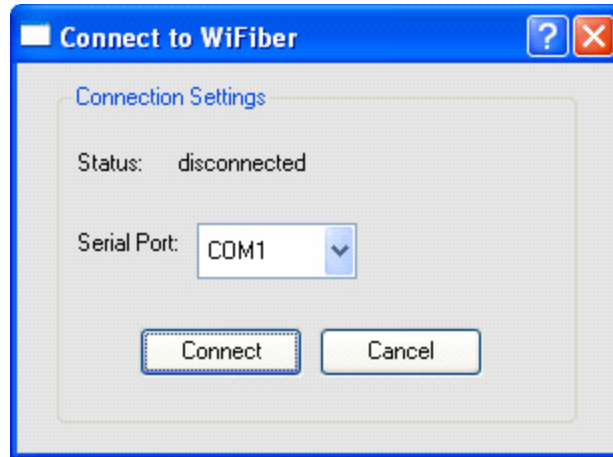

- 2 Select the appropriate Serial Port from the list and click **Connect**.

E.4 WiFiber Installer overview

The WiFiber Installer Console is an application that displays tabbed pages when accessed. Each tab provides real-time data that supports configuration, peaking, and alarm status that is useful when commissioning radios. The following sections describe the features and operations of each tab.

E.4.1 Main tab

The Main tab (Figure E-6) provides an overview of real-time radio data, and enables configuration of DAC A and DAC B.

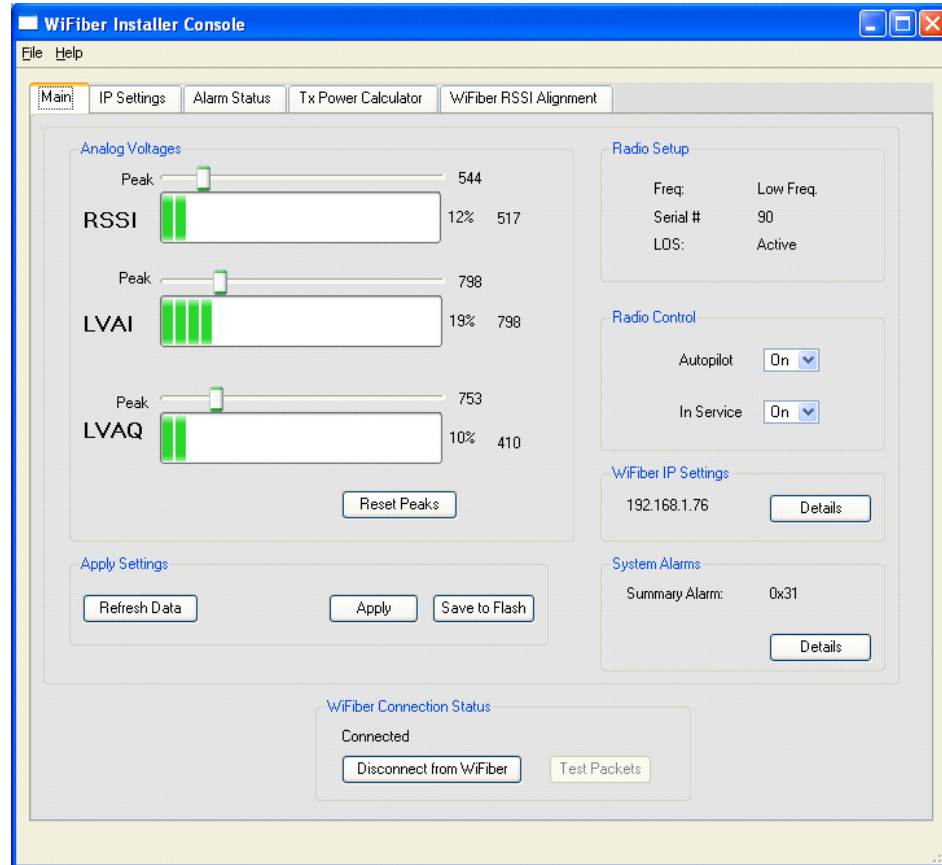

Figure E-6 WiFiber Installer Console - Main screen.

Analog Voltages

- RSSI - displays real-time RSSI value.
- LVAI - displays real-time Costas Lock (LVAI) value.
- LVAQ - displays real-time Costas Lock (LVAQ) value.
- Slider bar - enables adjustment of values.
- Reset Peaks button - resets peak calculations if slider bar is used to adjust values.

Radio Setup

- Freq - Describes radio frequency, either *low-band* or *high-band*.
- Serial # -Describes serial interface.
- LOS - Indicates LOS signal output, either *Active* or *Inactive*

Radio Control

- Autopilot - Enables or disables Costas Lock monitoring. Default is *On*.

- In Service - Enables or disables loopback testing. Default is *On*. When exercising loopbacks the In Service mode should be *Off*.

Note:

In Service mode must be set to *On* when bringing radio back into service after exercising loopbacks.

WiFiber IP Settings

Displays current IP settings. Click **Details** button to display IP Settings Tab information.

System Alarms button

Displays a zero value when there are no Summary Alarms. A value other than zero will display if there is an alarm condition. If there is an alarm condition, click the **Details** button, which displays the **Alarm Status** tab information.

Apply Settings

- **Apply** button - reconfigures the Ethernet Interface with the new settings, but does not save the configuration to the radio. If you reset the radio, the new settings are not saved to flash!
- **Save** button - saves the current settings to flash (only after pressing Apply). This process will take up to 10 seconds.
- **Refresh** button - reverts to the previous settings if they have not been applied and saved. Apply - press after adjusting screen values. This

E.4.2 IP Settings tab

The IP Settings tab (Figure E-7) enables you to configure the radio using an IP address, gateway and subnet mask. The default radio IP address is 192.168.1.230.

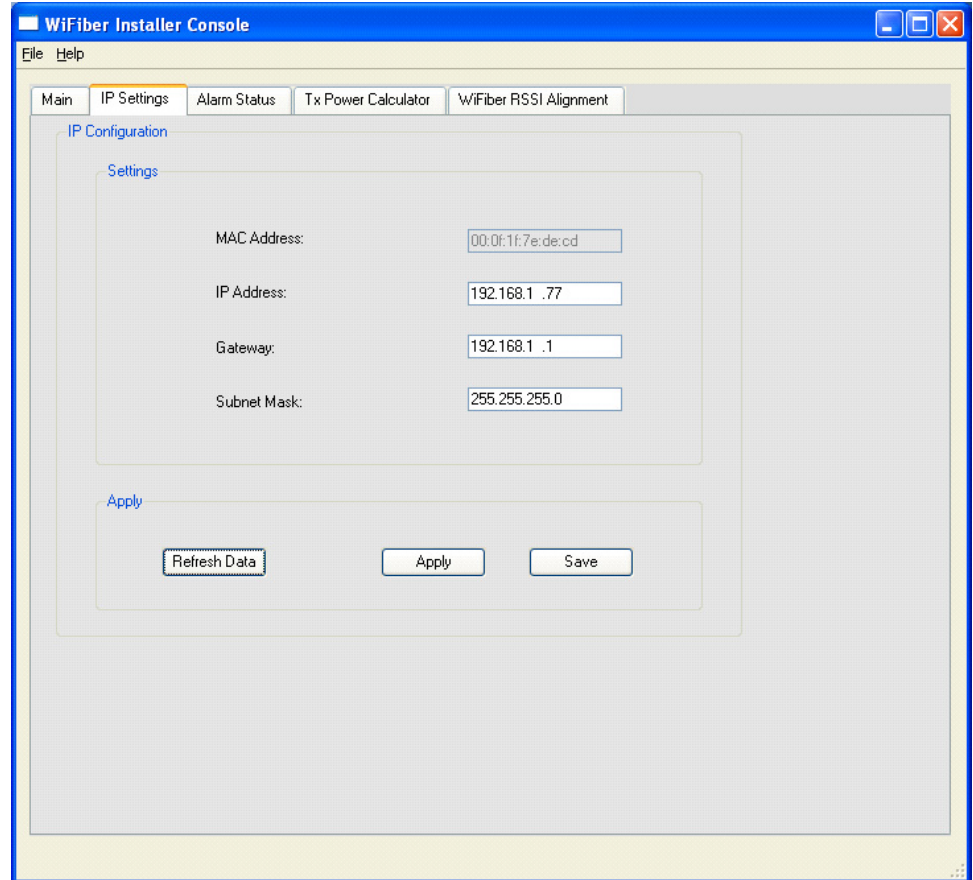

Figure E-7 WiFiber Installer Console - IP Settings screen.

- ❑ **Apply** button - reconfigures the Ethernet Interface with the new settings, but does not save the configuration to the radio. If you reset the radio, the new settings are not saved to flash!
- ❑ **Save** button - saves the current settings to flash (only after pressing Apply). This process will take up to 10 seconds.
- ❑ **Refresh** button - reverts to the previous settings if they have not been applied and saved.

Note:



Always **Apply** IP settings and then **Save** configuration, otherwise the configuration is not saved to the radio.

E.4.3 Alarm Settings tab

The Alarm Settings tab (Figure E-8) supports real-time troubleshooting. This screen displays radio alarm status. A non zero value indicates that the radio is in an alarm condition. The list box displays errors specific to that particular alarm. If there are too many to display, use the scroll bar to view remaining alarms. The update count displays shows how many times this alarm status has been updated. A status for each of these sub alarms may be viewed in greater detail in the CLI.

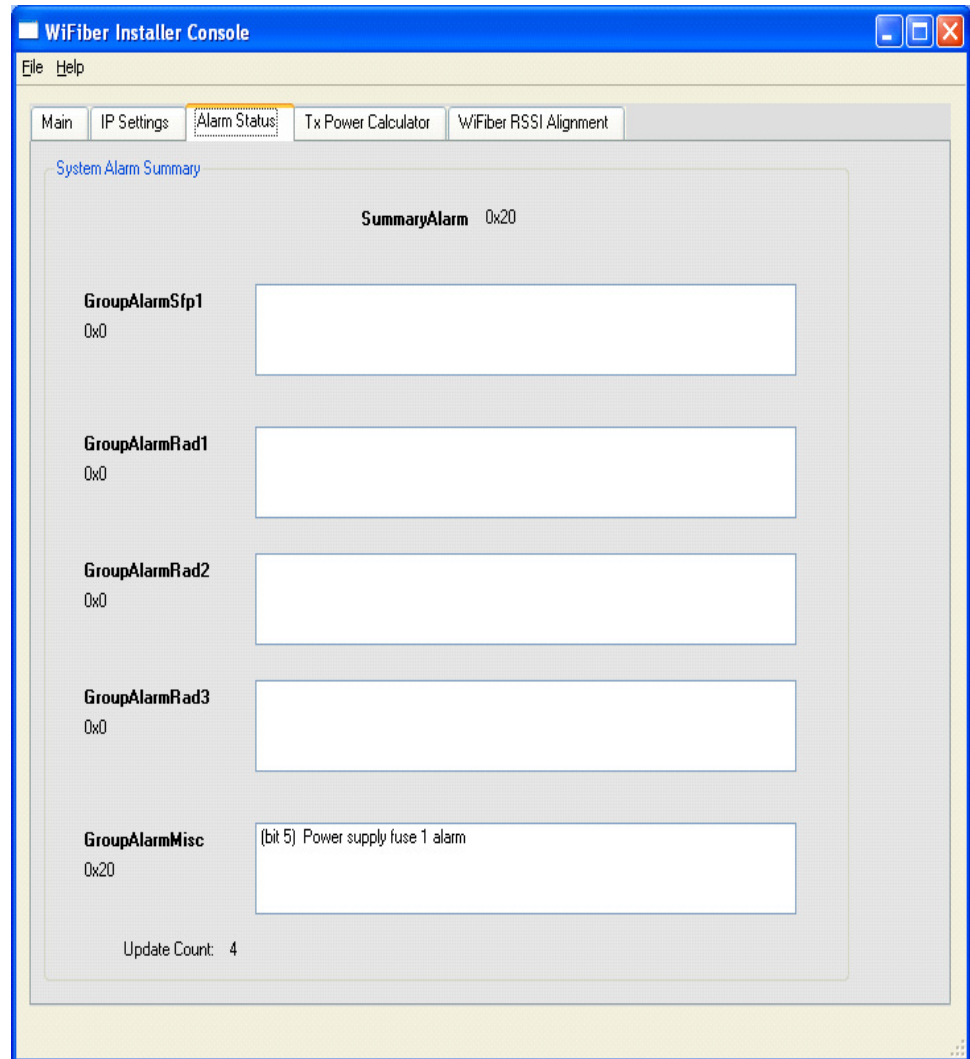
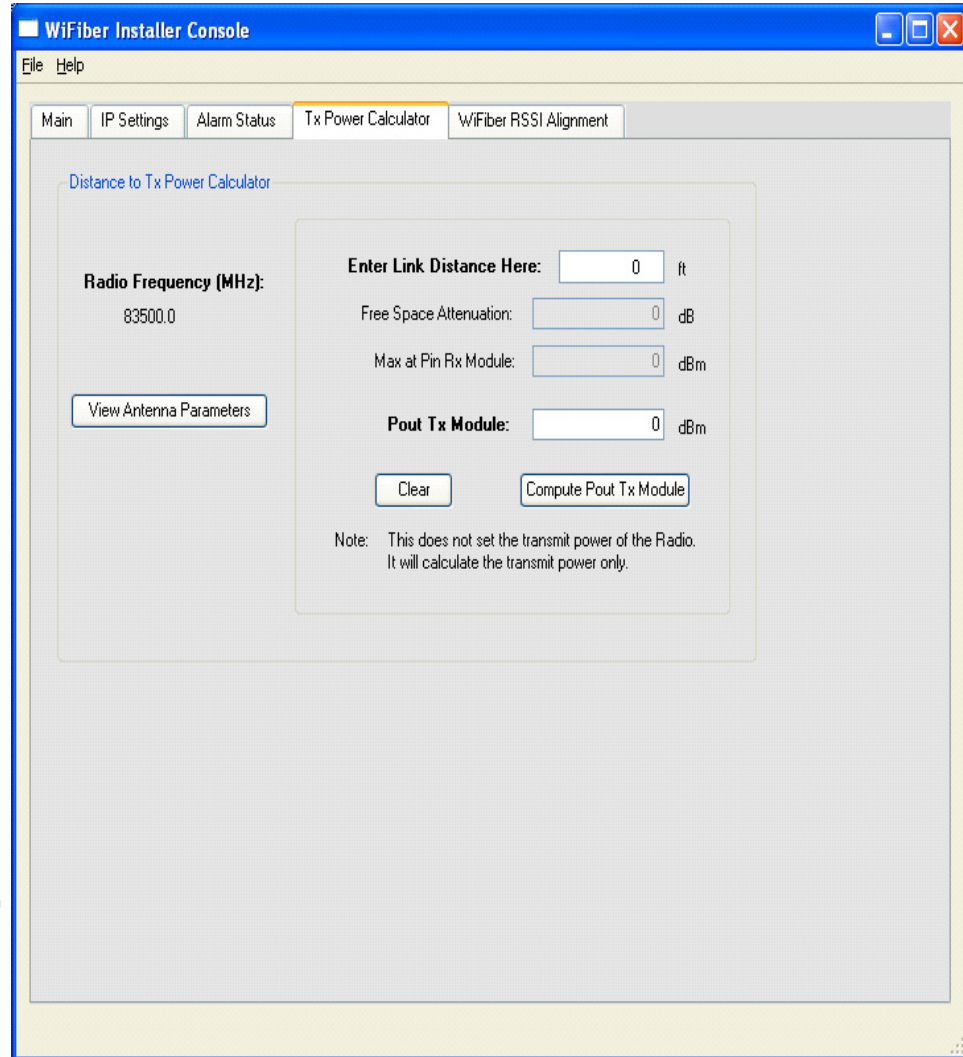

Figure E-8 WiFiber Installer Console - Alarm Status screen.

E.4.4 TxPower Calculation tab

The TxPower Calculator tab (Figure E-9) enables you to calculate Tx Power and is used with the Tx Power Specifications that came with the radio to support radio peaking.



Dac A	Dac B	Power Detector	Power Level
4059	4059	1216	20
1155	4059	1052	19
1105	4059	916	18
1090	4059	760	17
1030	4059	666	16
975	4059	544	15
880	4059	436	14
820	4059	396	13
690	4039	336	12
600	1400	278	11
600	1240	236	10
600	1160	172	9
600	1140	148	8
600	1120	130	7
600	1095	104	6
600	1080	94	5
600	1050	82	4
600	1010	58	3
600	950	46	2
600	900	36	1
600	850	32	0

Figure E-9 WiFiber Installer Console - TxPower Calculator screen.

- **Enter link Distance Here** - Enter the value of the distance between links.
- **Compute Pout Tx Module** button - Click after entering link distance to compute Tx power. Use this value to look up Tx values for Dac A and Dac B in the Tx Power Specifications chart that came with each radio.
- **Clear** button - This clears the value from the Link Distance text box.
- **View Antenna Parameters** button - Displays antenna parameters (Figure E-10) used to calculate Tx Pout value. Click **Cancel** button to close screen and return to TxPower Calculation screen.

Example:
Tx Power Specification

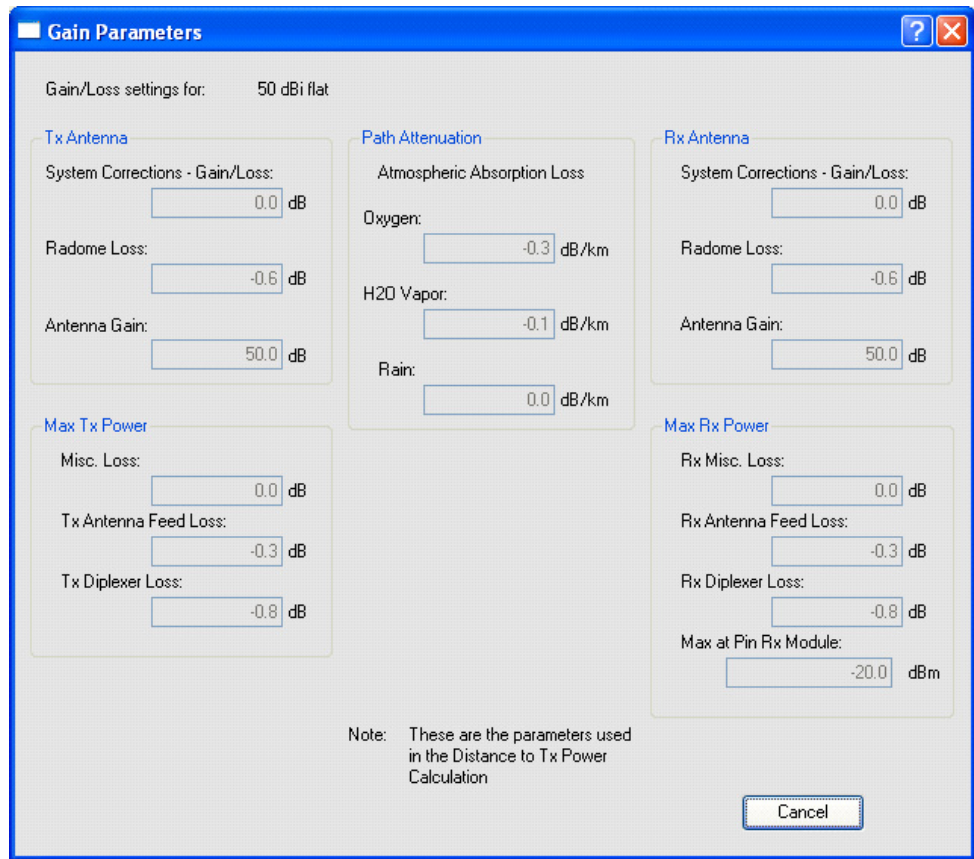

Figure E-10 WiFiber Installer Console - Tx Power Calculator parameters.

E.4.5 WiFiber RSSI Alignment tab

The WiFiber RSSI Alignment tab (Figure E-11) displays the current and peak RSSI values and allows control of the Tx Bias Attenuators by setting the DAC A and DAC B settings. Exercise caution while setting DACA and DAC B because setting an inappropriate value can result in too high of a transmit power which will damage the receiver of the far-end radio.

Warning: Radio damage



Do not exceed **20 dBm** Antenna Port power levels as this power level or higher will damage radio receivers.

The Peak RSSI value is the peak RSSI reached when the peak process started or since the Reset Peaks button was pressed. This screen visually illustrates the current RSSI compared to its historical peak indicating if you're getting closer or further from the desired peak position.

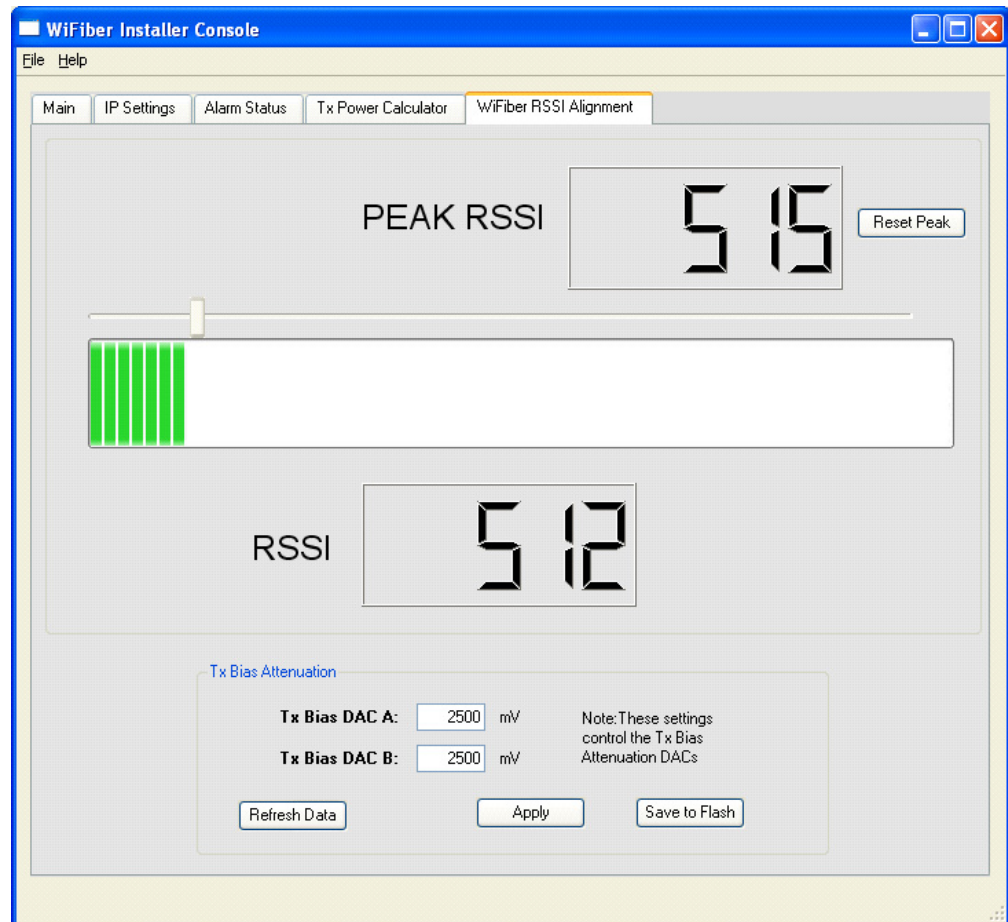

Figure E-11 WiFiber Installer Console - RSSI Alignment screen.

- **Reset Peak** button - Refreshes values on screen after changing screen-values.

- **Apply** button - Applies the settings to the WiFiber radio, but does not save the settings to the radio. If you reset the radio, the new settings are not saved to flash!
- **Save** button - saves the current settings to flash (only after pressing Apply). This process will take up to 10 seconds.

Note:



Always **Apply** settings and then **Save** configuration, otherwise the configuration is not saved to the radio.



Glossary

A

azimuth. The angular distance measured along the horizon between a reference point (usually the observer's bearing) and another object.

B

Baird. Roof mounting design for antennas that does not alter or penetrate a roof.

BER. Bit Error Rate. Percentage of errored bits received compared to total number of bits received.

BERT. Bit Error Rate Test. A means of determining transmission quality.

BPSK. BiPhase Shift Key. Digital frequency modulation technique used for sending data.

Bootloader. The set of operations the radio performs when turning on the radio.

C

Cat 5. Performance category for inside wire and cable systems.

Cat 6. Shielded twisted pair cabling standard supporting signaling rates in support of Gigabit ethernet.

Costas Lock. Phase lock method with LVAI and LVAQ values indicate radio link communications.

D

dB. Decibel. Unit of measure of sound level or signal strength.

DC. Direct Current.

DS-3. Digital Service level 3. Signal in the T-3 carrier carrying a multiple of 28 DS-1 signals (672 DS-0s) or 44.736 Mbps.

E

EMT. Type of protective conduit.

F

FDD. Frequency Division Duplexing. In an FDD system, simultaneous transmission and reception of radio signal is possible. The mode of communication is facilitated by having a frequency channel with two separate operating frequencies: one for transmission and the other for reception.

FPGA. Field Programmable Gate Array.

G

GHz. Gigahertz. Billions of cycles per second. Frequency measurement used to measure microprocessors.

gigabit. Unit of measurement in data communication representing one billion bits of data transmission, the same as 1000 megabits.

gigabit ethernet. A high speed form of Ethernet (LAN technology) that transfers data at ~1 gigabit per second.

H

hoist. Apparatus for lifting objects.

K

KBPS. Killobits per second.

L

LAN. Local Area Network. Local data communications network linking computer and peripheral devices.

last mile (last kilometre). Final distance of delivering communications connectivity to a customer.

LOS. Loss of Signal.

M

MAN. Metropolitan Area Network. High speed intra-city network linking multiple locations. Typically extends as far as 50km and operates from 1 Mbit/s to 200 Mbps. Provides integrated services: real-time data, voice, and image transmission.

Mbps. Million bits per second.

MIB. Management Information Base.

N

NAS. Network Attached Storage. Storage device that attaches directly to a network.

O

OC-3. Optical Carrier level 3. Sonnet channel carrier equal to three DS-3s (155.52 Mbps).

OC-12. Optical Carrier level 12. SONET channel of 622.08 Mbps.

OID. Object Identifier.

OSI layer. Open System Interconnect layer. Seven layer model that identifies engineering standards to allow computer systems to exchange data.

P

Physical layer. Most basic layer of OSI model that moves raw bit data bits over a communication channel - Level 1.

PLL. Phased-Locked Loop. Voltage or current-driven electronic circuit that constantly adjusts or locks in phase on the frequency of an input signal.

Polarization. The plane in which the electromagnetic wave travels. The radios have to be installed as a horizontal link or a vertical link.

Power Absorber. An object between two links that can absorb Tx power signal.

PSH. Post-tension design for antennas.

PVC. Type of protective conduit.

R

raster. Scanning, following a pattern, from side to side and from top to bottom.

RCM. Routing Controller Module.

RF. Radio Frequency. Electromagnetic waves between 10 kHz and 300 GHz.

RSSI. Received Signal Strength Indicator.

S

SAN. Storage Area Network. A network that links data storage devices with associated to storage servers and systems.

Saturation. When so much power is transmitted to a link that the amplifier cannot take any more signals and starts to distort the signal creating errors.

SFP. Small Form-Factor Pluggable. Specification for a new generation of optical modular transceivers.

side lobe. The portion of an antenna response pattern that is not contained in the main beam. The strongest lobe is in the pointing direction of a directional antenna, which is determined by 1) wavelength, 2) properties of the antenna and feed system, and 3) mutual interference such as reflected rays.

SNMP. Simple Network Management Protocol. A set of protocols developed to manage complex networks.

SONET. Synchronous Optical Network. International transmission standard that allows interworking of multiple vendor networks.

T

TFTP. Trivial File Transfer Protocol.

TPI. Threads per inch.

Trap. Notification event issued by a managed device to the network management station when a significant event (not necessarily an outage, a fault, or a security violation) occurs.

U

UDP. User Datagram Protocol. Connection protocol running on top of IP networks. Used for broadcasting direct messages over a network.

V

VAC. Volts Alternating Current.

VDC. Volts Direct Current.

Varbind. Variable binding containing a name and a value.

W

WAN. Wide Area Network. Extensive data network linking local area networks.



Index

A

- access privileges
 - SNMP **40**
- alarm
 - getting alarm dump **56**
- alarm dump **56**
- Alarm structures **110**
- Alarms
 - GroupAlarmMisc object **115**
 - GroupAlarmRad1 object **117**
 - GroupAlarmRad3 object **117**
 - GroupAlarmSfp1 object **112**
 - SummaryAlarm **111**
 - SummaryAlarm object **111**
- Antenna
 - assembling **15**
 - description **12**
 - Mounting **15**
- Antenna Input
 - protective cover **15**

B

- Beam **4**
- Bitmaps
 - GroupAlarmSfp1 **113**
- Bitmaps
 - GroupAlarmMisc **116**
 - GroupAlarmRad1 **117**
 - GroupAlarmRad3 **118**
 - SummaryAlarm **111**

C

- Cables
 - CAT5 cable drawing **104**
 - Cat5 jacket types **74**
 - connecting **19**
 - descriptions **13**
 - fiber-LC/SC 50/125 MM drawing **103**
 - fiber-LC/SC 62.5/125 MM drawing **102**

- fiber-LC/SC 9/125 SM Fiber drawing **101**
 - specifications **74**

- Cat5 jacket types **74**

- CLI
 - logging in **32**
 - navigating **33**
 - user privileges **32**

- CLI port settings **22**

- Commands
 - CONFIG **78**
 - CONFIG / CONF **92**
 - CONFIG / CONF / ASYNC **93**
 - CONFIG / CONF / CONTROL **93**
 - CONFIG / CONF / ETHERNET **95**
 - CONFIG / CONF / MISC **95**
 - CONFIG / CONF / SNMP **94**
 - CONFIG / CONF / TFTP **94**
 - CONFIG / DIAG **95**
 - CONFIG / RAD **84**
 - CONFIG / RAD / AD **89**
 - CONFIG / RAD / CONTROL **87**
 - CONFIG / RAD / DIAG **86**
 - CONFIG / RAD / DS **90**
 - CONFIG / RAD / FLAG **89**
 - CONFIG / RAD / STATUS **86**
 - CONFIG / RAD / THRES **86**
 - CONFIG / RAD / TRAP **90**
 - CONFIG / RAD/ BASE **85**
 - CONFIG / SFP / SFP1 **78**
 - CONFIG / SFP / SFP1 / AD **81**
 - CONFIG / SFP / SFP1 / CALIB **81**
 - CONFIG / SFP / SFP1 / EXT **79**
 - CONFIG / SFP / SFP1 / FLAG **82**
 - CONFIG / SFP / SFP1 / GBEAM **83**
 - CONFIG / SFP / SFP1 / STATUS **82**
 - CONFIG / SFP / SFP1 / THRES **80**
 - CONFIG / SFP / SFP1 / VENDMEM **83**
 - CONFIG / SFP / SFP1/ BASE **79**
 - CONFIG / STAT **91**
 - CONFIG / STAT / ALARM **92**
 - CONFIG / STAT / PSM **91**

- CONFIG / STAT / REV **91**
- CONFIG / STAT / SFP **92**
- CONFIG/ RAD / EXT **85**
- CONFIG/ SFP / SFP1 / TRAP **83**
- Commissioning radio
 - configuration **22, 24**
 - peaking **21**
- Communications
 - SSH **35**
 - telnet **36**
- Configurations
 - saving **37**
- Costas Lock
 - about **65**
 - diagnostics **55**
 - lost signal **55**
 - verifying **65**
- D**
- debug, radio vitals **61**
- Demarcation requirements **10**
- Description
 - CLI command tree **78**
 - GroupAlarm trap objects **112**
 - GroupAlarmMisc traps **116**
 - GroupAlarmRad1 trap objects **117**
 - GroupAlarmRad3 trap objects **118**
 - GroupAlarmSFP1 trap objects **114**
- Diagnostics
 - alarm status **56**
 - general **55**
 - radio error status **62**
 - RSSI values **63**
 - setting traps **57**
- E**
- External Loopback Configuration **69**
- F**
- Fiber Cable
 - LC/SC 50/125 MM drawing **103**
 - LC/SC 62.5/125 MM drawing **102**
 - LC/SC 9/125 SM drawing **101**
- Frequency
 - specification **4**
- G**
- Grounding Lug **18**
- GroupAlarmMisc object **115**
- GroupAlarmRad1 object **117**
- GroupAlarmRad3 object **117**
- GroupAlarmSfp1 object **112**
- H**
- Horizontal polarization
 - illustration **100**
- I**
- Installation **10**
 - commissioning the radio **21**
 - configuring **22, 24**
 - connecting cables **18**
 - peaking **21**
 - preparing site **14**
 - required tools **11**
- Installer Console
 - about **120**
 - Alarm Settings tab operations **125**
 - configuring **120**
- IP address
 - configuring **35**
 - default radio address **22**
- IP Settings tab
 - operations **124**
- L**
- LED description **19**
- log
 - enabling **58, 60**
- Logs
 - enabling/disabling **58**
 - viewing **61**
- Loopbacks
 - activating/deactivating **68**
 - configuring external loopback **69**
 - configuring radio local loopback **70**
 - configuring SFP external loopback **69**
 - debugging configuration **71**
- Lost Signal
 - Costas Lock **55**
- M**
- Main tab
 - operations **122**
- MIB
 - about **40**
 - access privileges **40**
 - hierarchy **108**
 - walk example **41**
- Mounting Assembly
 - assemble **14**
 - description **13**
 - pole mount screws **14**
- Mounting Assembly Collar
 - description **16**
- Mounts
 - rooftop **74**

tower/pole mounts **74**
 wall mount **74**

N

Noise figure **4**

O

optical link
 verifying **66**

P

Peaking **21**
 description **21**

Polarity
 horizontal **15**
 horizontal, mechanical drawing **100**
 vertical **15**
 vertical, mechanical drawing **98**

Pole Mount
 adjustability **14**

Pole mount screws
 sizes **14**

Power
 connecting **18**
 General specifications **4**
 general specifications **4**
 transmitter specifications **75**

Power Cable
 pinouts **106**

Power Calculator Utility Tool
 example **75**
 using **23**

Power levels
 calculating **23**

Power Supply
 cable run specifications **74**
 connecting **20**
 mechanical drawing **105**

R

Radio
 block diagram **6**
 configuring **22, 24**
 description **12**
 grounding **19**
 mechanical drawing (rear 2) **99**
 mechanical drawing (rear1) **98, 120**
 mounting **16**
 options **3**
 transporting **13**

Radio connectors
 description **18**

Radio Head Mounting Bolts **15**

Radio local loopback **70**

Radio modulation
 disabling **70**

Radio Subsystem **6**
 antenna **8**
 controller **8**
 modem **8**
 power supply **8**
 transceiver **7**

RADIUS
 integrating **36**

RCM
 alarm structures **110**

Rooftop mounting **74**

RSSI
 verifying **63**

RSSI Alignment tab
 operations **128**

S

Safety line
 radio **16**

Serial Port
 configuring **35**

SFP external loopback configuration **69**

Site preparation **14**

Site Survey
 site preparation **14**

SNMP
 setting up communications **40**

Software
 upgrading **48**

Specifications
 antenna size **4**
 cable run **74**
 frequency **4**
 mechanical drawings **97, 119**
 monitoring **4**
 mounts **74**
 power input **4**
 temperature range **4**
 transmit power **4**

SummaryAlarm **111**

SummaryAlarm object **111**

T

Temperature range
 specification **4**

Trap Receivers **41**

Traps
 Group Alarm **112**
 GroupAlarmMisc **116**
 GroupAlarmRad1 **117**
 GroupAlarmRad3 **118**
 GroupAlarmSfp1 Object **114**

- setting **41**
- Summary Alarm **112**
- Varbinds **110**

- Troubleshooting
 - activating/deactivating loopback mode **68**
 - Configuring loopbacks **68**
 - debugging loopback configuration **71**
 - external loopback configuration **69**
 - general **68**
 - MIB browser **67**
- TxPower Calculation tab
 - operations **126**

U

- U-clamp
 - attaching **15**

V

- Vertical polarization
 - illustration **98, 120**



GigaBeam Headquarters
470 Springpark Place ■ Suite 900 ■ Virginia 20170 ■ USA